

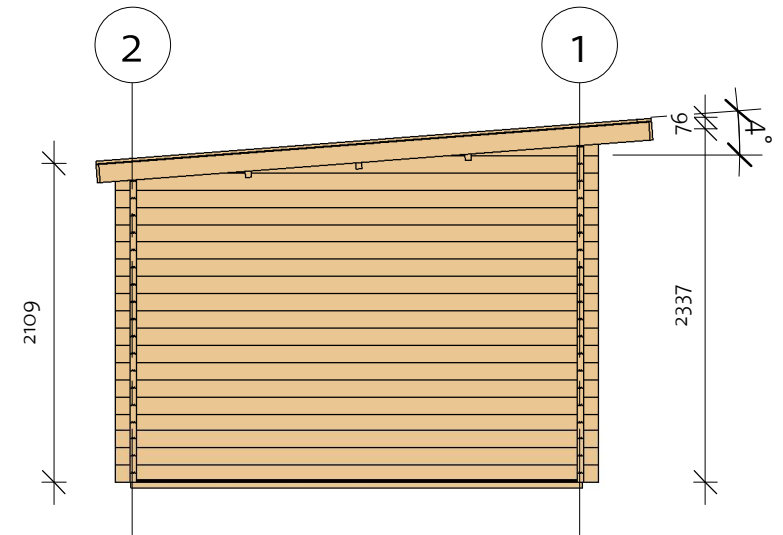

Cleo 40 (400x300)

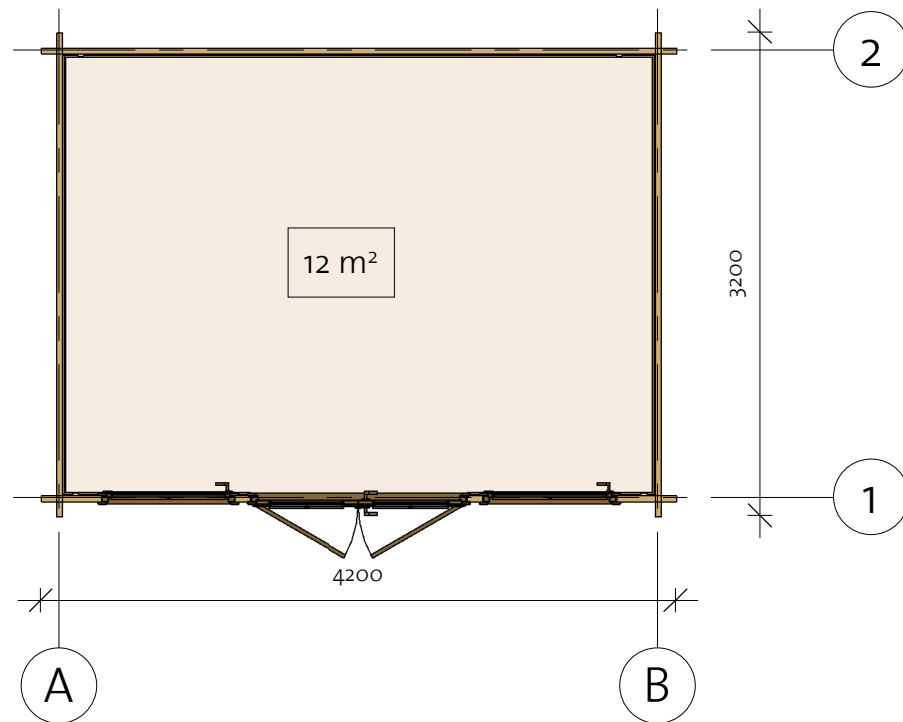
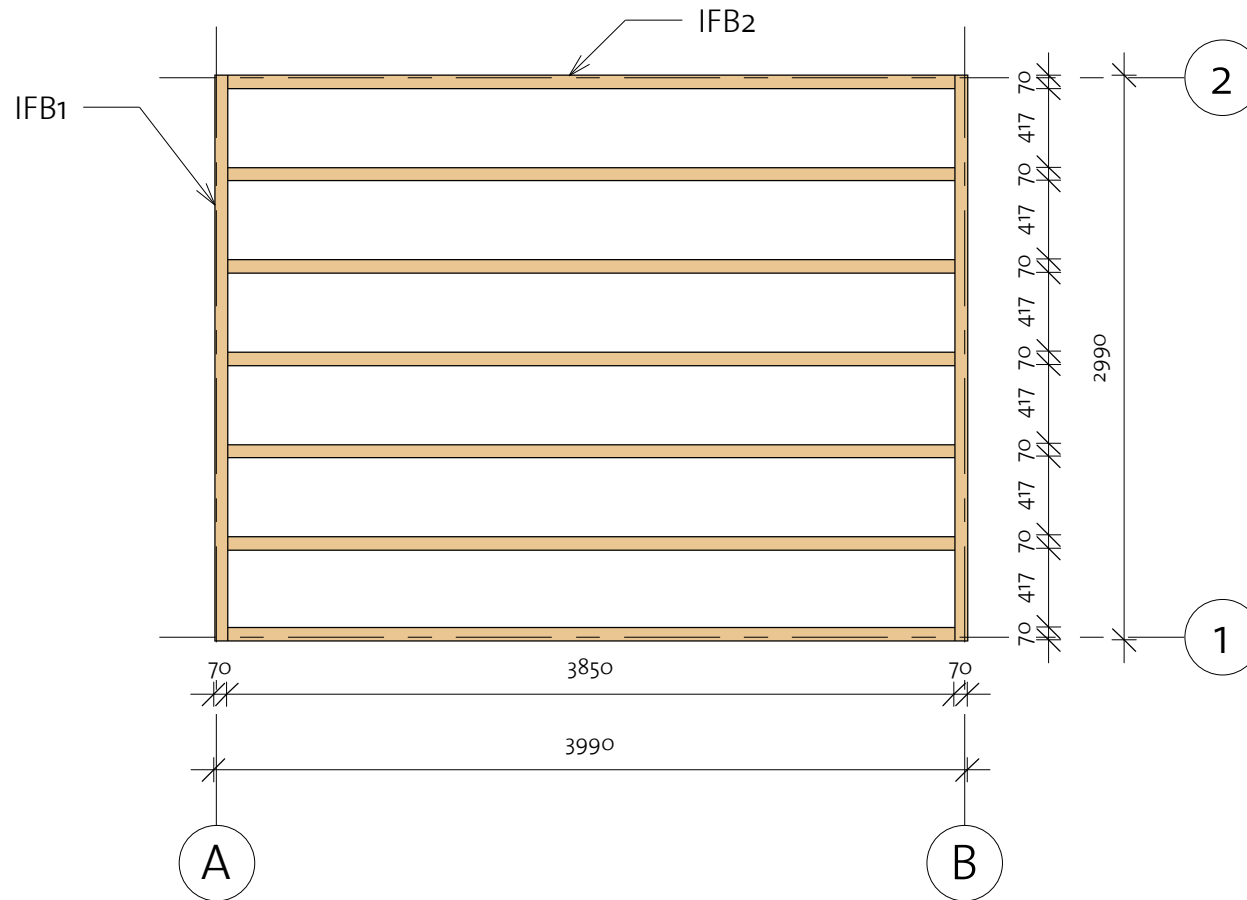

Cleo 40 (400x300)

Foundation





Impregnated foundation beams				
Mark	Type	Profile	Count	Length
IFB1	IFB 70x40		2	2990
IFB2	IFB 70x40		7	3850

Cleo 40 (400x300)

Floor Plan

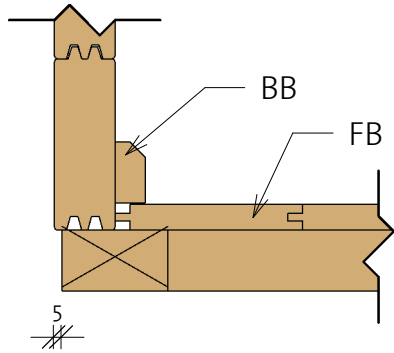
① Baseboard



Floor Schedule				
Mark	Type	Profile	Count	Length
FB	FB 17x114		36	2918
BB1	BB 20x40		2	4000
BB2	BB 20x40		2	3000

91923053_211203

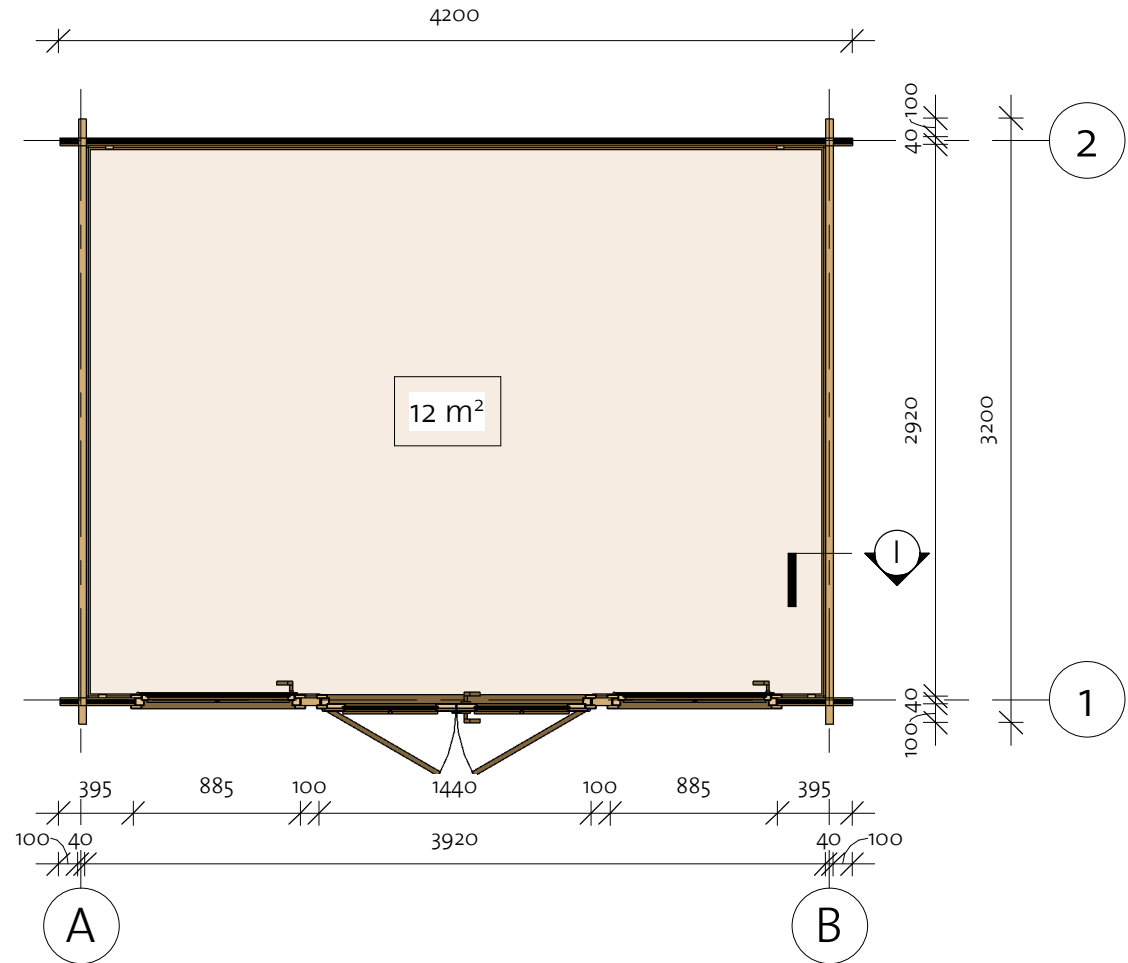

Cleo 40 (400x300)

Wall 2

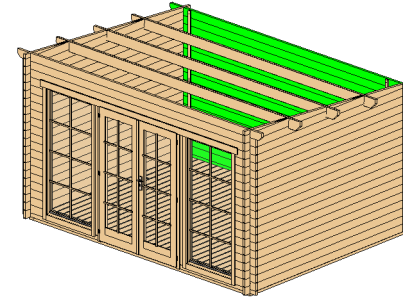

Wall 2			
Mark	Profile	Count	Cut Length

2BL-1	40X57	1	4200
2LG-1	40X114	17	4200
2TL-1	40X114	1	4400

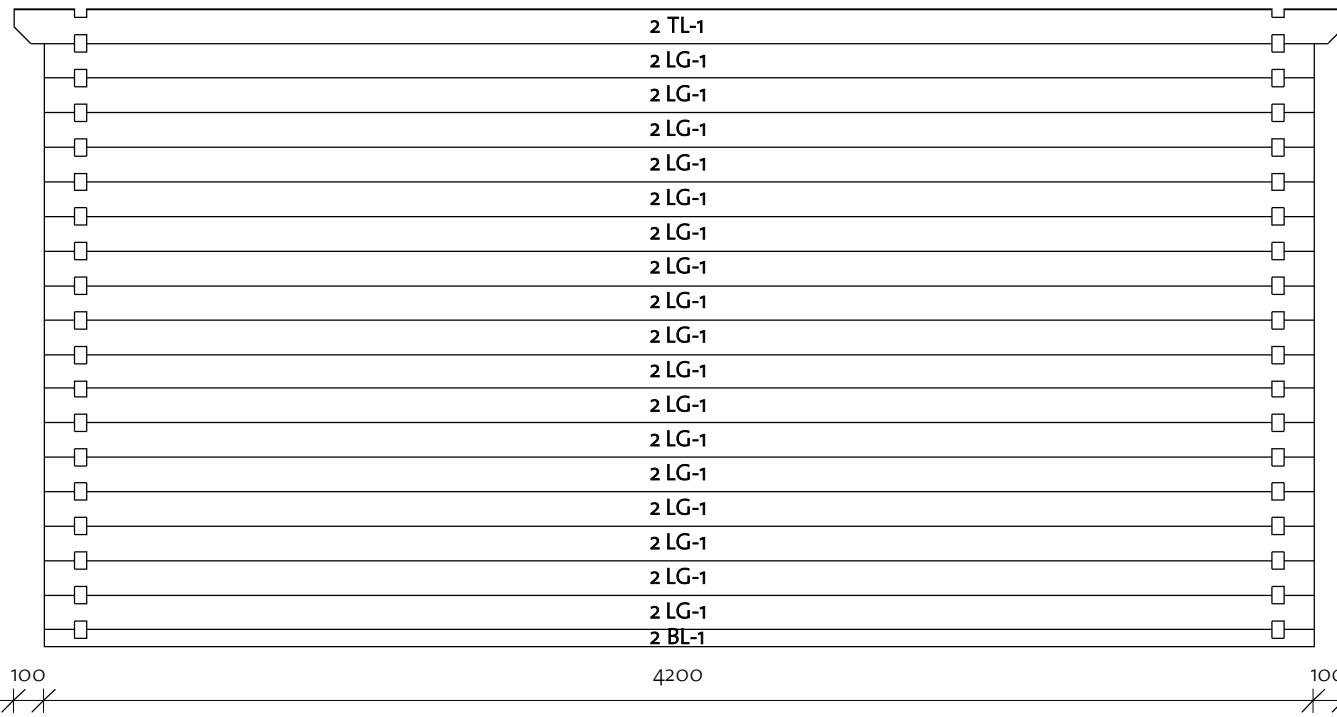

Log Profile Wall 2	
Profile	Profile

40X57	
40X114	
40X114	

Cleo 40 (400x300)

Wall A

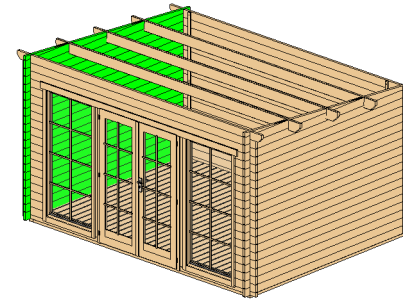

Wall A			
Mark	Profile	Count	Cut Length

ALG-1*	40x114	1	841
ALG-2*	40x114	1	2310
ALG-3	40x114	18	3200
ALG-4*	40x114	1	3200

* Gable - delivered premounted

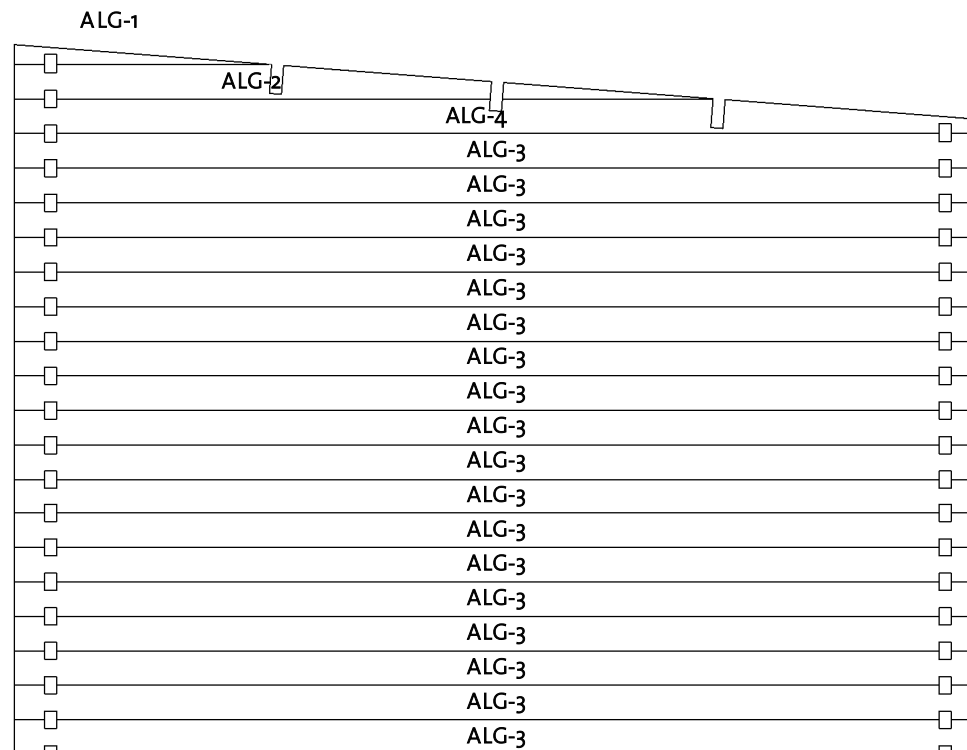

Log Profile Wall A	
Profile	Profile

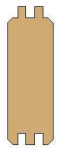
40x114	
--------	---------------------------------------------------------------------------------------

Cleo 40 (400x300)

Wall B

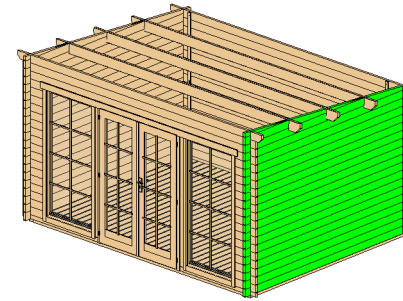

Wall B			
Mark	Profile	Count	Cut Length

BLG-1*	40X114	1	841
BLG-2*	40X114	1	2310
BLG-3	40X114	18	3200
BLG-4*	40X114	1	3200

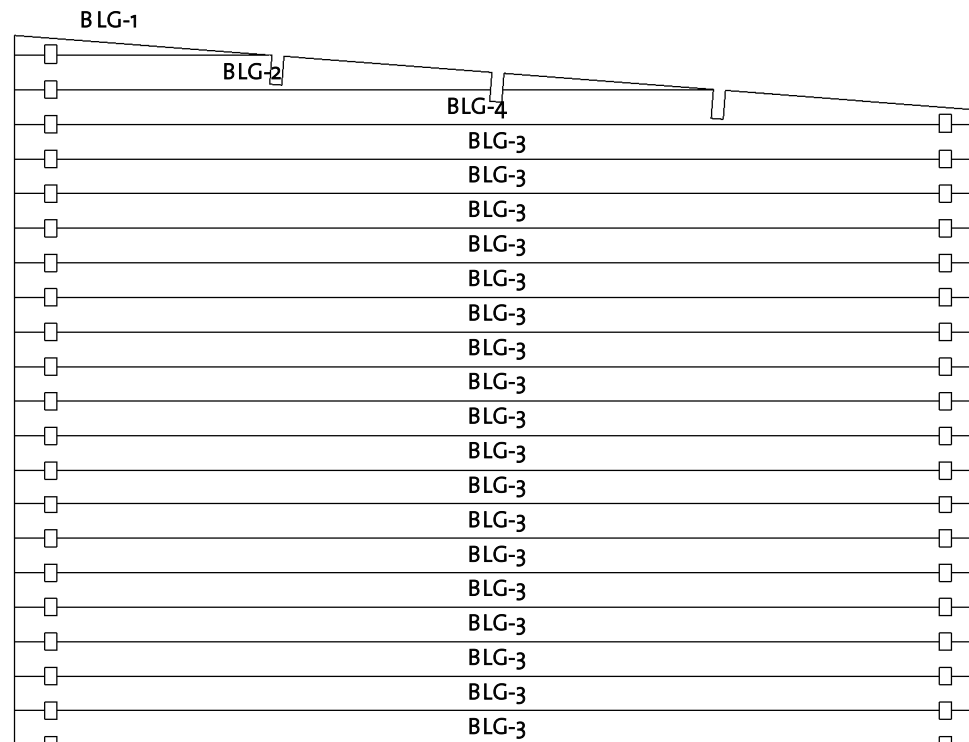

* Gable - delivered premounted

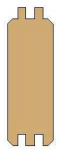

Log Profile Wall B	
Profile	Profile

40X114	
--------	---------------------------------------------------------------------------------------

Cleo 40 (400x300)

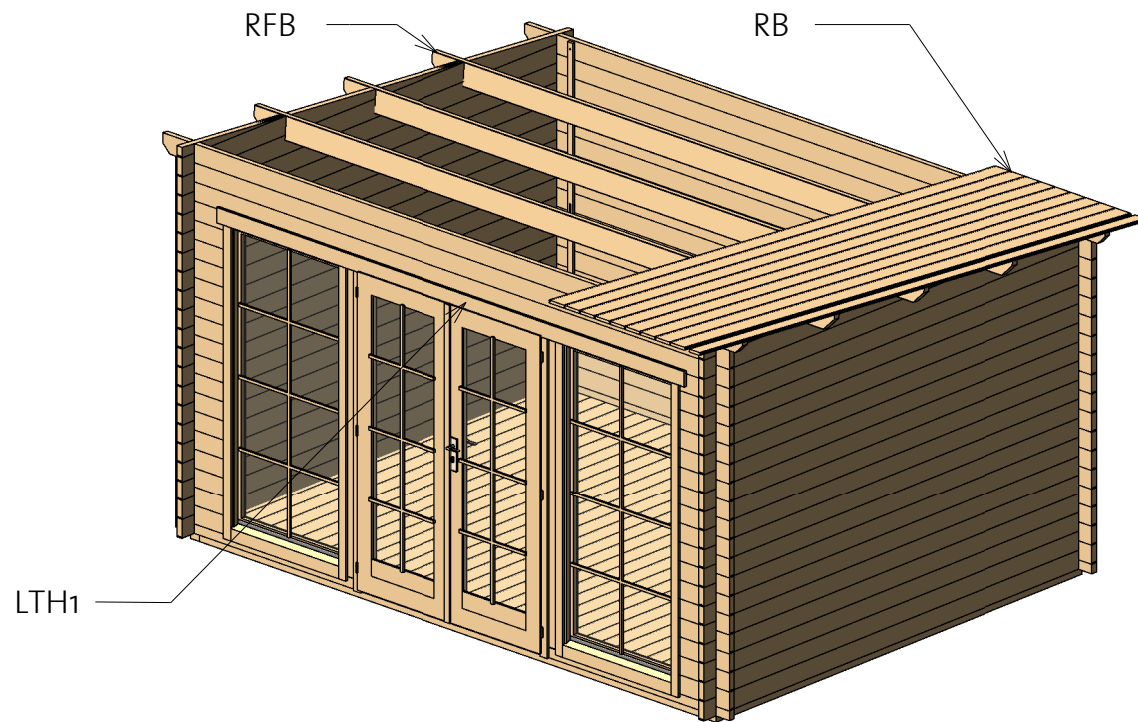
Roof 1



Roof				
Mark	Type	Profile	Count	Length
RFB	Beam 40X143		3	4400
RB	17X114		40	3650

Lath list				
Mark	Type	Profile	Count	Length
LTH1	18x95		2	3550

Cleo 40 (400x300)

Roof 2

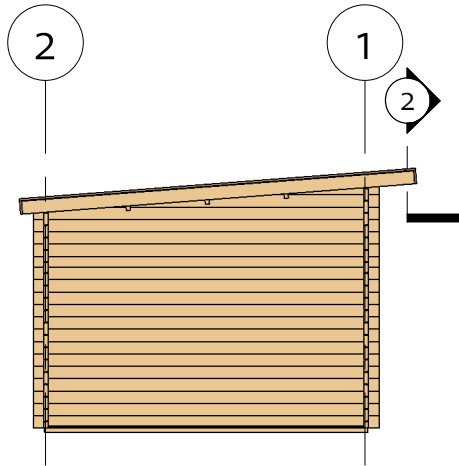

② Facia

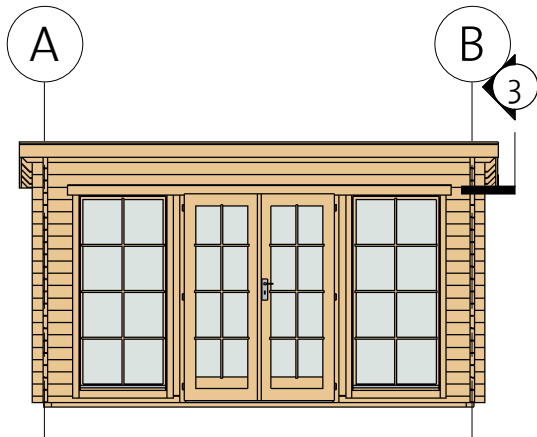
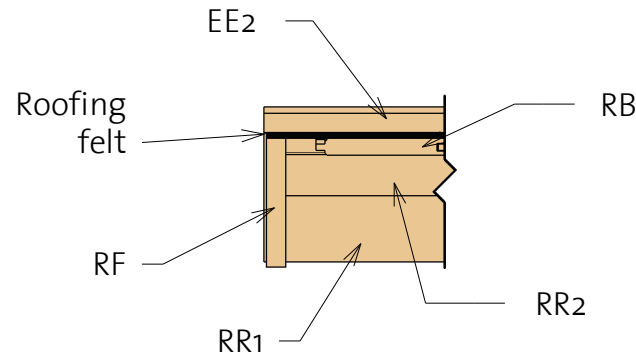

③ Roof Reinforcement

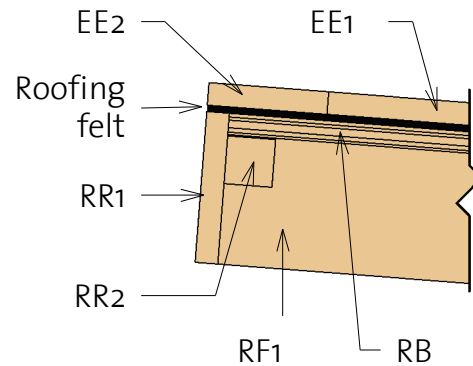

Fascia Schedule

Mark	Type	Profile	Count	Length
EE1	Eave Edging 18x95		2	3590
EE2	Eave Edging 18x95		1	4440
RF	Roof Fascia 18x120		2	3650
RR1	Roof reinforcement 18x120		2	4440
RR2	Roof reinforcement 38x38		2	4400

Cleo 40 (400x300)

Extras

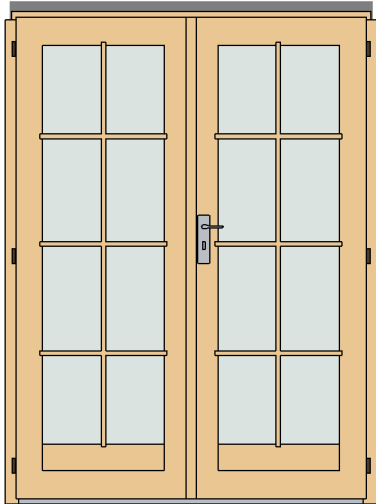

Door Schedule				
Mark	Type	Width	Height	Count
CDD3R	Classic double door 3 right	1425	1955	1
DCB8	Door Crossbar 8	--	--	2

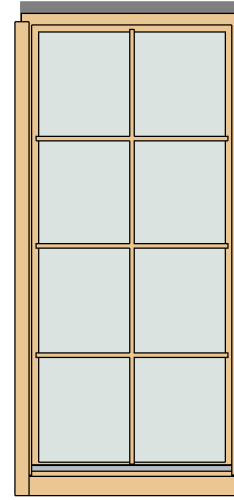

Window Schedule				
Mark	Type	Width	Height	Count
CW4R	Classic window 4 right	875	1890	2
WCB8	Windows Crossbar 8	--	--	2

Fasteners/Extras		
Name	Type	Count

Hitblock	300-400 mm	
Bolts	M8 x 70	12
Screws	5,0 x 70	15
Nails	1,4 x 40	40
Screws	6,0 x 140	50
Screws	4,0 x 40	585

Family	Count	Length
--------	-------	--------



Windboard 18x40	4	2200
-----------------	---	------





Cleo 40 (400x300)

List of all items 1



Impregnated foundation beams

Mark	Type	Profile	Count	Length
IFB1	IFB 70x40		2	2990
IFB2	IFB 70x40		7	3850





Roof

Mark	Type	Profile	Count	Length
RFB	Beam 40x143		3	4400
RB	17x114		40	3650

Floor Schedule

Mark	Type	Profile	Count	Length
FB	FB 17x114		36	2918
BB1	BB 20x40		2	4000
BB2	BB 20x40		2	3000

Fascia Schedule

Mark	Type	Profile	Count	Length
EE1	Eave Edging 18x95		2	3590
EE2	Eave Edging 18x95		1	4440
RF	Roof Fascia 18x120		2	3650
RR1	Roof reinforcement 18x120		2	4440
RR2	Roof reinforcement 38x38		2	4400

Lath list

Mark	Type	Profile	Count	Length
LTH1	18x95		2	3550

Cleo 40 (400x300)

List of all items 2

Wall 1			
Mark	Profile	Count	Cut Length

1BL-1	40X57	2	1380
1LG-1	40X114	34	395
1LG-2	40X114	2	4200
1TL-1	40X114	1	4400

Wall 2			
Mark	Profile	Count	Cut Length

2BL-1	40X57	1	4200
2LG-1	40X114	17	4200
2TL-1	40X114	1	4400

Wall A			
Mark	Profile	Count	Cut Length



ALG-1*	40X114	1	841
ALG-2*	40X114	1	2310
ALG-3	40X114	18	3200
ALG-4*	40X114	1	3200

Wall B			
Mark	Profile	Count	Cut Length

BLG-1*	40X114	1	841
BLG-2*	40X114	1	2310
BLG-3	40X114	18	3200
BLG-4*	40X114	1	3200

* Gable - delivered premounted

Log Profiles	
Profile	Profile

40X57	
40X114	

Log Profiles	
Profile	Profile

40X114	
--------	---------------------------------------------------------------------------------------

Columns			
Mark	Profile	Count	Length

CM	Post 100X40	2	1890
----	----------------	---	------