

# Enfield/cEnzo I D 40 (480x480)

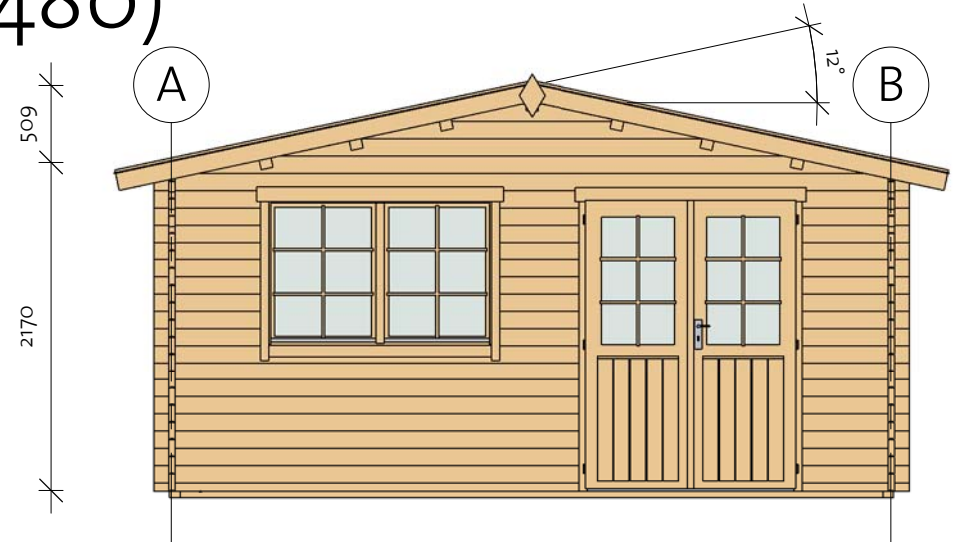

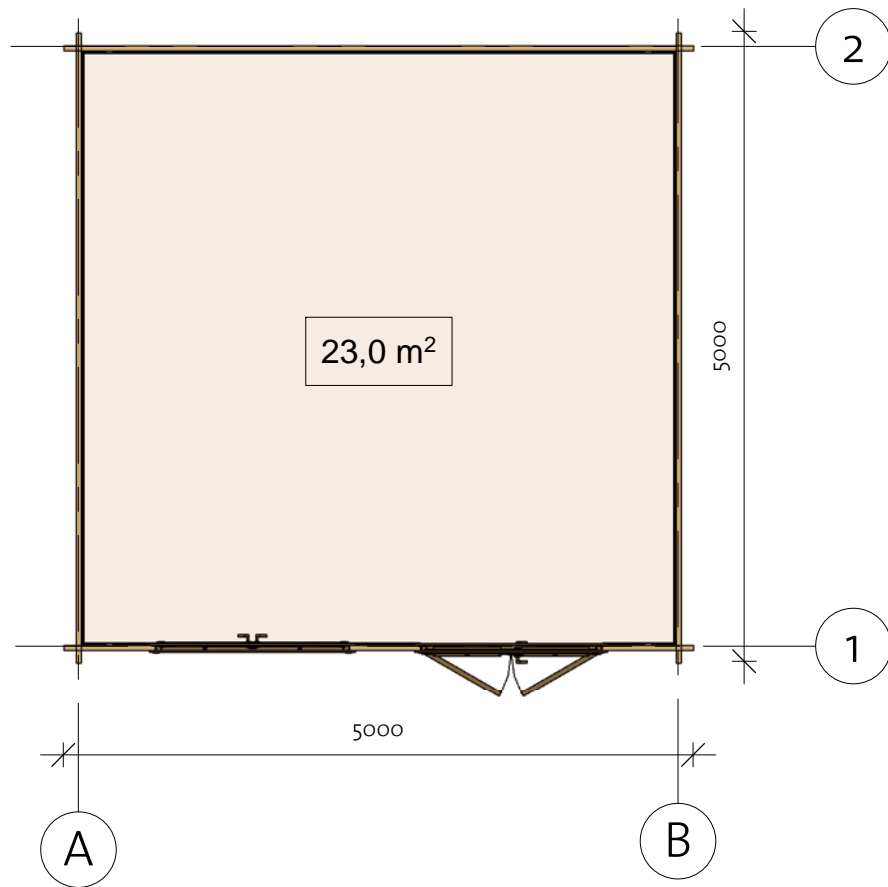
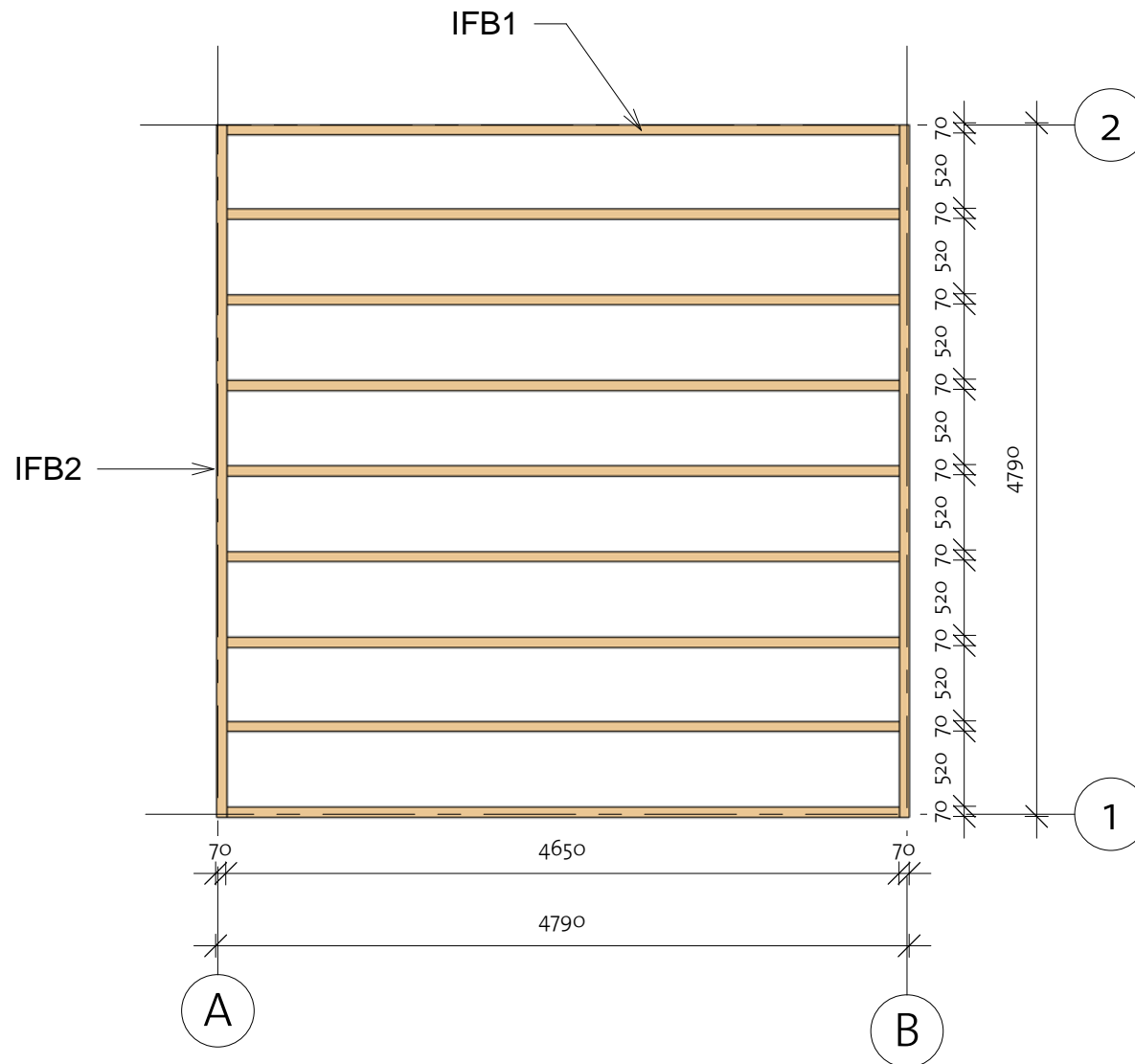

# cEnzo I D 40 (480x480)

Foundation



Impregnated foundation beams				
Mark	Type	Profile	Count	Length

IFB1	IFB 70x40		9	4650
IFB2	IFB 70x40		2	4790

# cEnzo I D 40 (480x480)

Floor Plan

① Baseboard

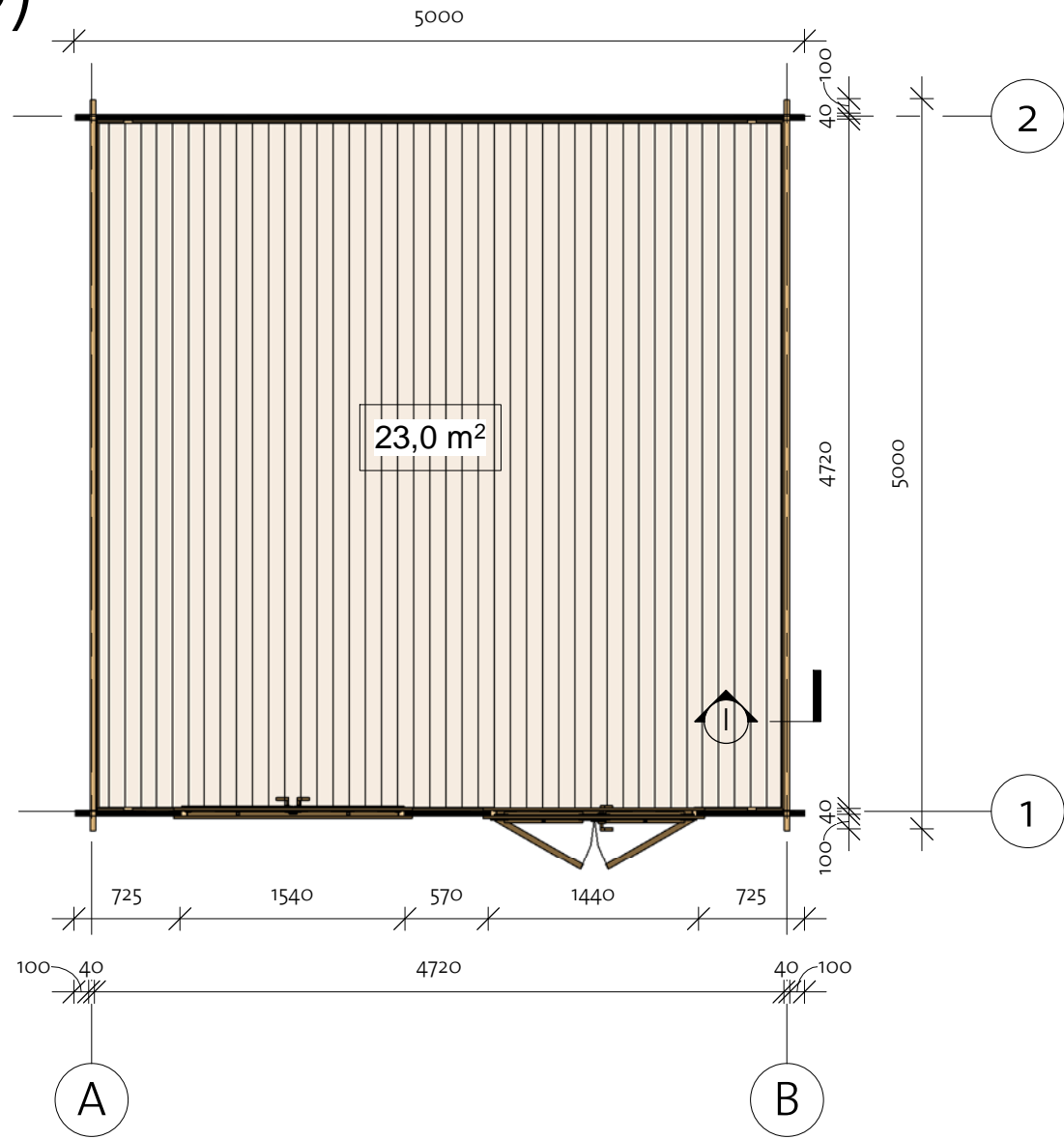
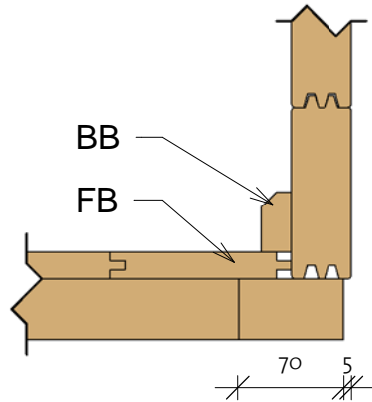

Floor Schedule

Mark	Type	Profile	Count	Length
FB	FB 18x110		44	4714
BB	BB 20x40		4	4800

# cEnzo I D 40 (480x480)

Wall 1

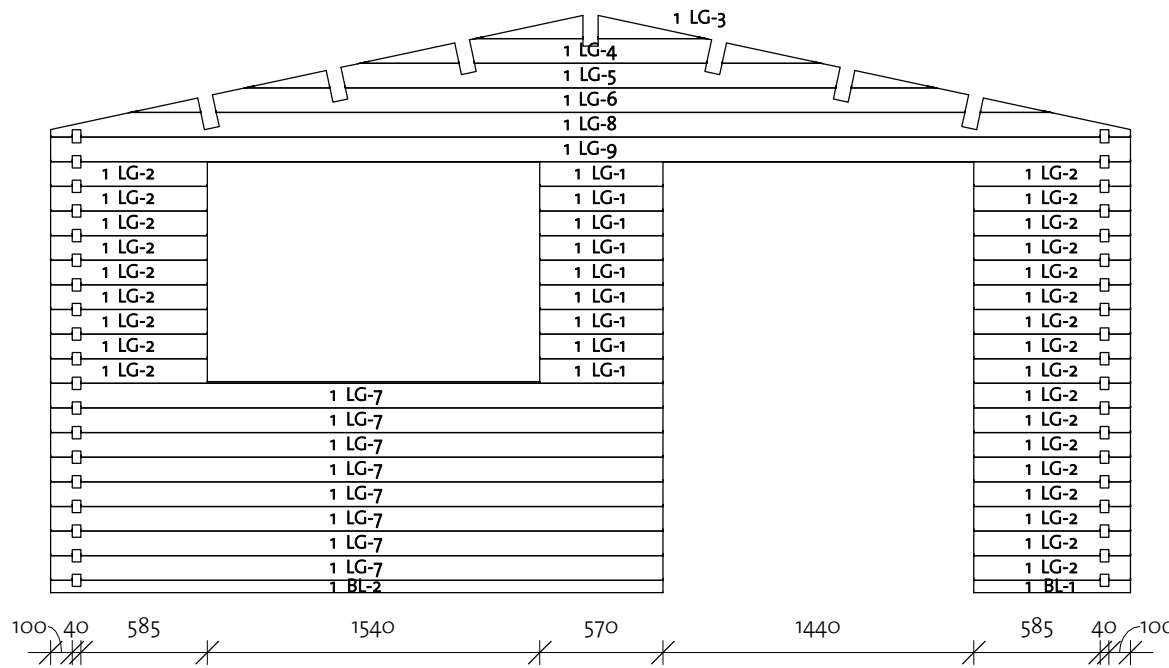
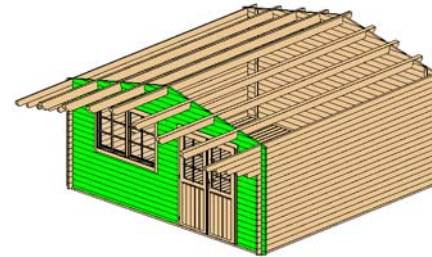



Wall 1			
Mark	Profile	Count	Cut Length

1BL-1	40X57	1	725
1BL-2	40X57	1	2835
1LG-1	40X114	9	570
1LG-2	40X114	26	725
1LG-3*	40X114	1	1070
1LG-4*	40X114	1	2134
1LG-5*	40X114	1	3198
1LG-6*	40X114	1	4263
1LG-7	40X114	8	2835
1LG-8*	40X114	1	5000
1LG-9	40X114	1	5000

\* Gable - delivered premounted

Log Profile Wall 1	
Profile	Profile

40X57	
40X114	

# cEnzo I D 40 (480x480)

Wall 2

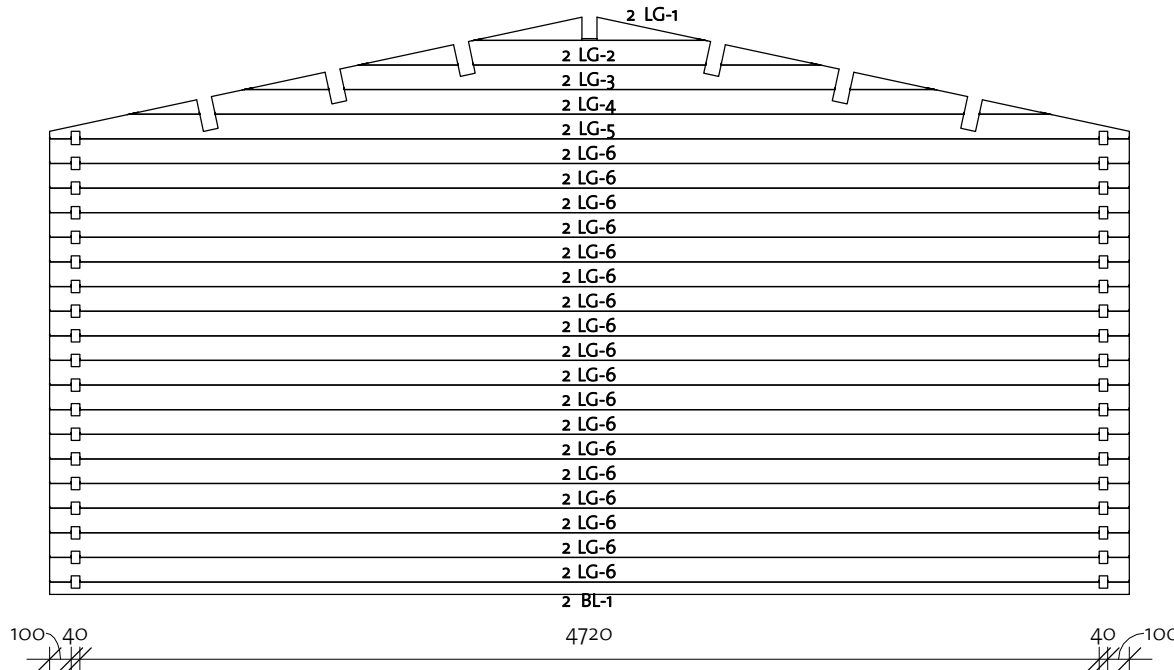
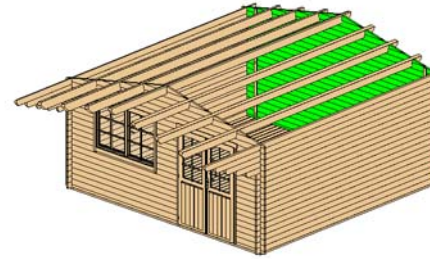

Wall 2			
Mark	Profile	Count	Cut Length

2BL-1	40x57	1	5000
2LG-1 *	40x114	1	1070
2LG-2 *	40x114	1	2134
2LG-3 *	40x114	1	3198
2LG-4 *	40x114	1	4263
2LG-5 *	40x114	1	5000
2LG-6	40x114	18	5000

\* Gable - delivered premounted

Log Profile Wall 2	
Profile	Profile

40x57	
40x114	

# cEnzo I D 40 (480x480)

Wall A

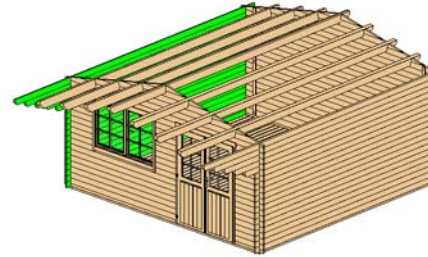

Wall A			
Mark	Profile	Count	Cut Length

ALG-1	40x114	14	5000
ALG-2	40x114	1	5280
ALG-3	40x114	1	5560
ALG-4	40x114	1	5840
ALG-5	40x114	1	4880
ALG-6	40x114	1	1240
ATL-1	40x122	1	1520
ATL-2	40x122	1	4980

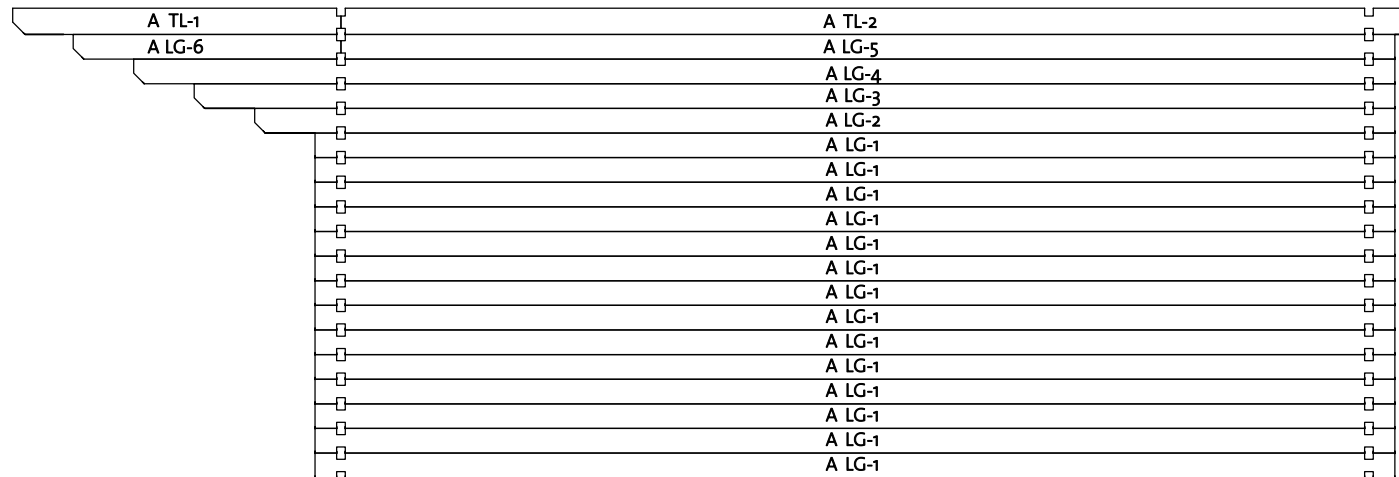

Log Profile Wall A	
Profile	Profile

40x114	
40x122	

# cEnzo I D 40 (480x480)

Wall B

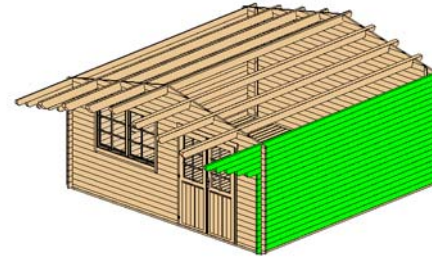

Wall B			
Mark	Profile	Count	Cut Length

BLG-1	40x114	14	5000
BLG-2	40x114	1	5280
BLG-3	40x114	1	5560
BLG-4	40x114	1	5840
BLG-5	40x114	1	4880
BLG-6	40x114	1	1240
BTL-1	40x122	1	1520
BTL-2	40x122	1	4980

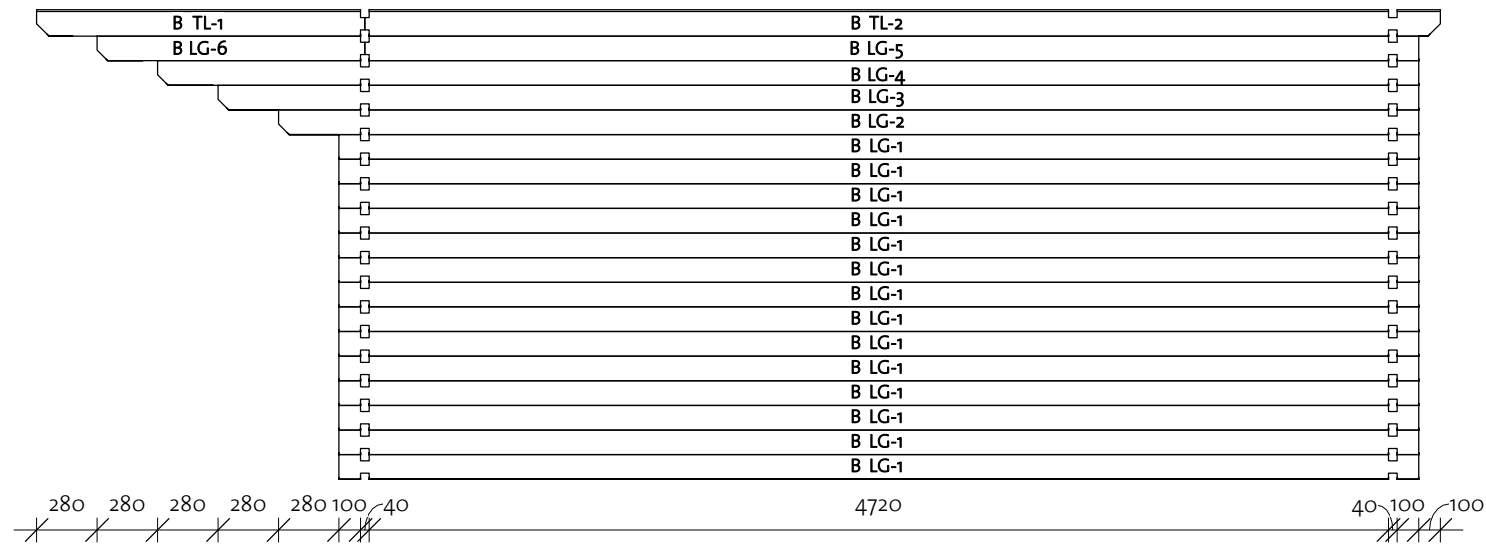





Log Profile Wall B	
Profile	Profile

40x114	
40x122	

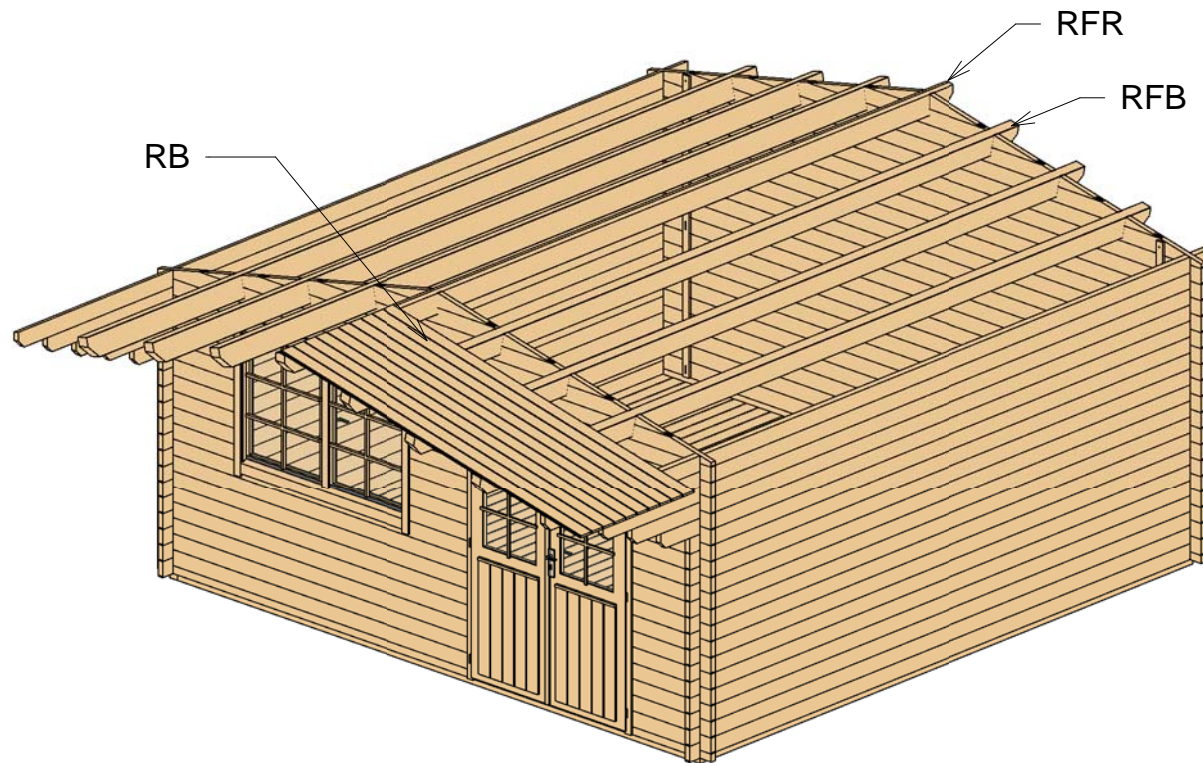
# cEnzo I D 40 (480x480)

Roof 1



Roof				
Mark	Type	Profile	Count	Length
RFR	Ridge 80x160		1	6500
RFB	Beam 80x160		6	6500
RB	18x110		120	2775



# cEnzo I D 40 (480x480)

Roof 2

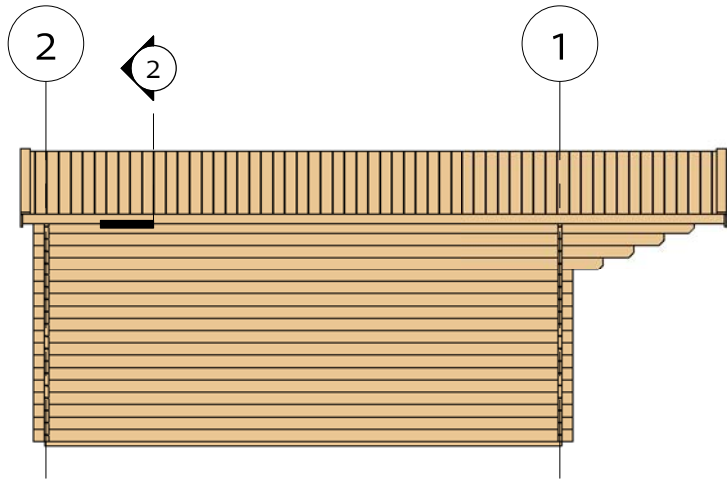

2) Fascia

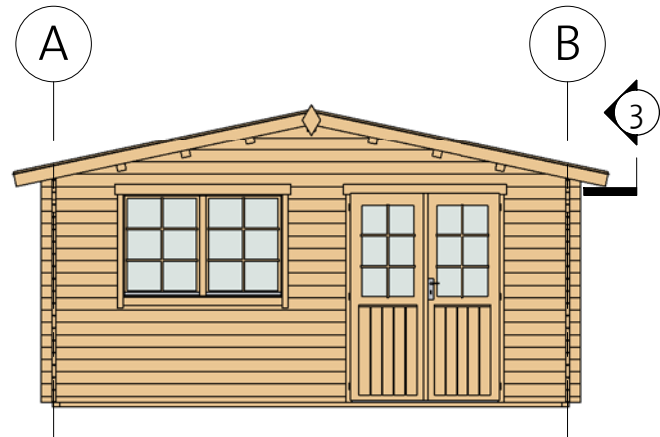
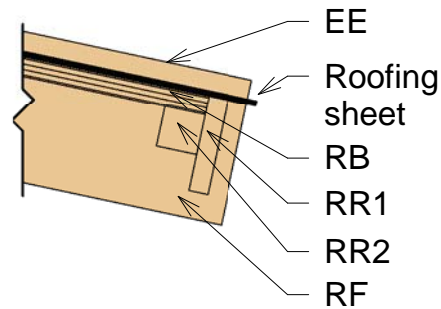

3) Roof Reinforcement

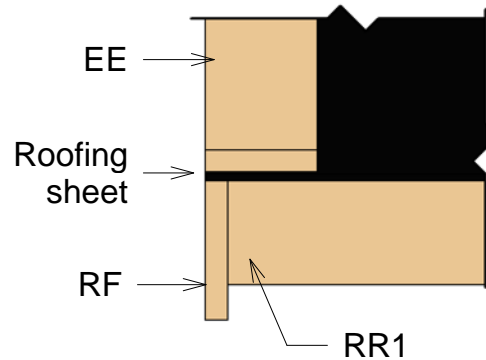

Fascia Schedule

Mark	Type	Profile	Count	Length
EE	Eave Edging 18x90		4	2815
RF	Roof Fascia 18x115		4	2815
RR1	Roof reinforcement 18x90		4	3250
RR2	Roof reinforcement 38x38		4	3250

# cEnzo I D 40 (480x480)

Extras



Door Schedule				
Mark	Type	Width	Height	Count
CDD1R	Classic double door 1 right	1425	1955	1
DCB6	Door Crossbar 6	--	--	2

Window Schedule				
Mark	Type	Width	Height	Count
CDW1	Classic double window 1	1530	990	1
WCB6	Windows Crossbar 6	--	--	2

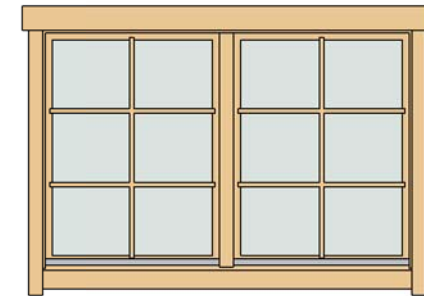

Fasteners & Extras		
Name	Type	Count

Hitblock	300-400 mm	
Bolts	M8 x 70	12
Screws	5,0 x 70	15
Nails	1,4 x 40	50
Screws	6,0 x 140	70
Screws	4,0 x 40	130
Screws	4,0 x 50	1100

Family	Count	Length
Windboard 18x40	4	2200



Family	Count
Romb	2



# cEnzo I D 40 (480x480)

## List of all items 1



### Impregnated foundation beams

Mark	Type	Profile	Count	Length
IFB1	IFB 70x40		9	4650
IFB2	IFB 70x40		2	4790



### Floor Schedule

Mark	Type	Profile	Count	Length
FB	FB 18x110		44	4714
BB	BB 20x40		4	4800

### Fascia Schedule

Mark	Type	Profile	Count	Length
EE	Eave Edging 18x90		4	2815
RF	Roof Fascia 18x115		4	2815
RR1	Roof reinforcement 18x90		4	3250
RR2	Roof reinforcement 38x38		4	3250

### Roof

Mark	Type	Profile	Count	Length
RFR	Ridge 80x160		1	6500
RFB	Beam 80x160		6	6500
RB	18x110		120	2775

# cEnzo I D 40 (480x480)

## List of all items 2

Wall 1			
Mark	Profile	Count	Cut Length

1BL-1	40X57	1	725
1BL-2	40X57	1	2835
1LG-1	40X114	9	570
1LG-2	40X114	26	725
1LG-3*	40X114	1	1070
1LG-4*	40X114	1	2134
1LG-5*	40X114	1	3198
1LG-6*	40X114	1	4263
1LG-7	40X114	8	2835
1LG-8*	40X114	1	5000
1LG-9	40X114	1	5000

Wall A			
Mark	Profile	Count	Cut Length

ALG-1	40X114	14	5000
ALG-2	40X114	1	5280
ALG-3	40X114	1	5560
ALG-4	40X114	1	5840
ALG-5	40X114	1	4880
ALG-6	40X114	1	1240
ATL-1	40X122	1	1520
ATL-2	40X122	1	4980

Log Profiles	
Profile	Profile

40X57	
40X114	

Wall 2			
Mark	Profile	Count	Cut Length

2BL-1	40X57	1	5000
2LG-1*	40X114	1	1070
2LG-2*	40X114	1	2134
2LG-3*	40X114	1	3198
2LG-4*	40X114	1	4263
2LG-5*	40X114	1	5000
2LG-6	40X114	18	5000

\* Gable - delivered premounted

Wall B			
Mark	Profile	Count	Cut Length

BLG-1	40X114	14	5000
BLG-2	40X114	1	5280
BLG-3	40X114	1	5560
BLG-4	40X114	1	5840
BLG-5	40X114	1	4880
BLG-6	40X114	1	1240
BTL-1	40X122	1	1520
BTL-2	40X122	1	4980

Log Profiles	
Profile	Profile

40X122	
--------	---