

Johnny 40 (380x380)

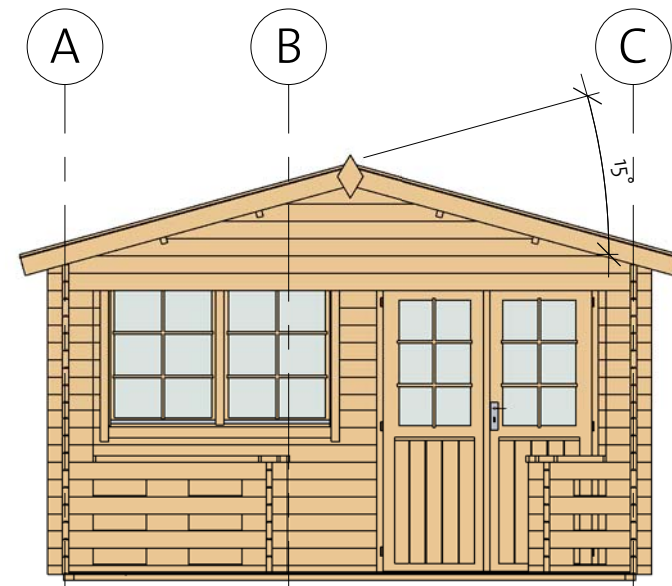

Johnny 40 (380x380)

Foundation

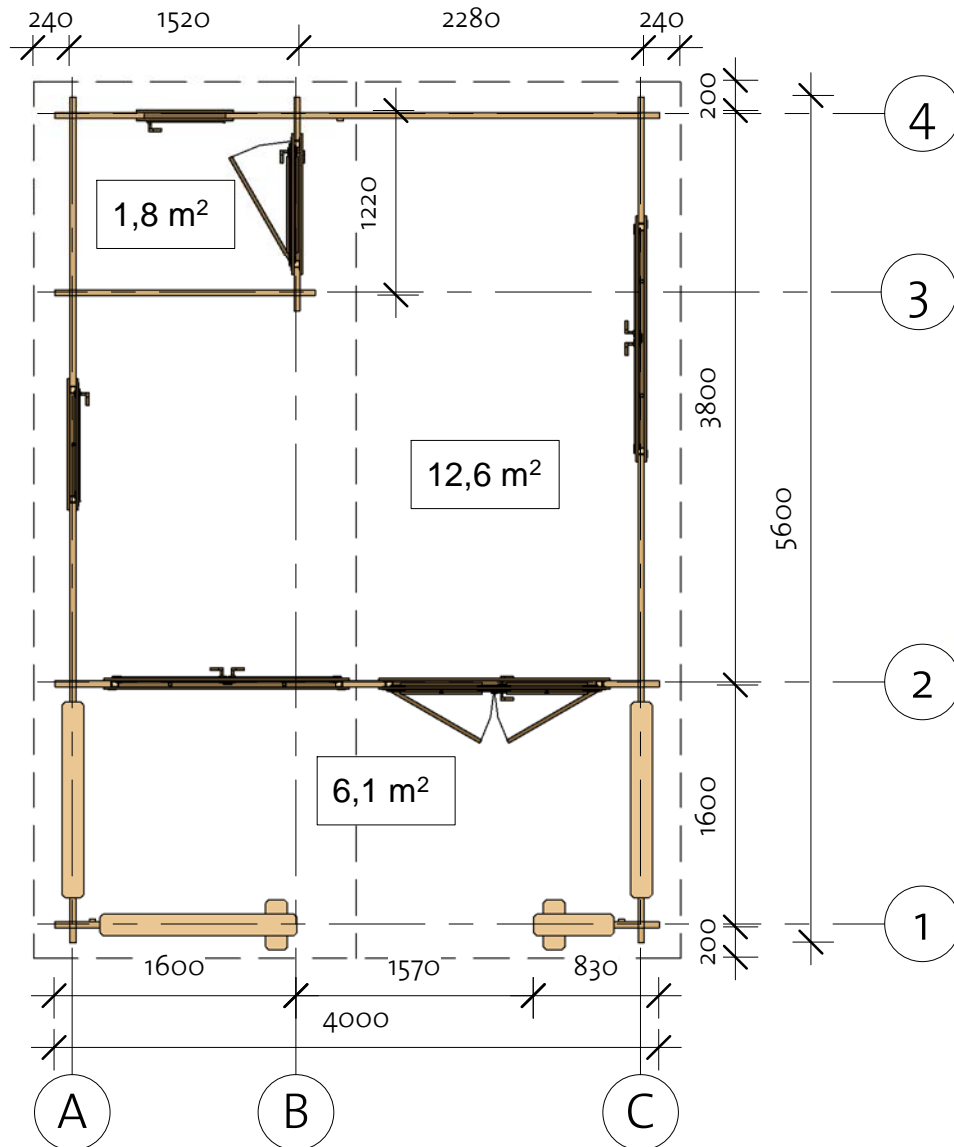
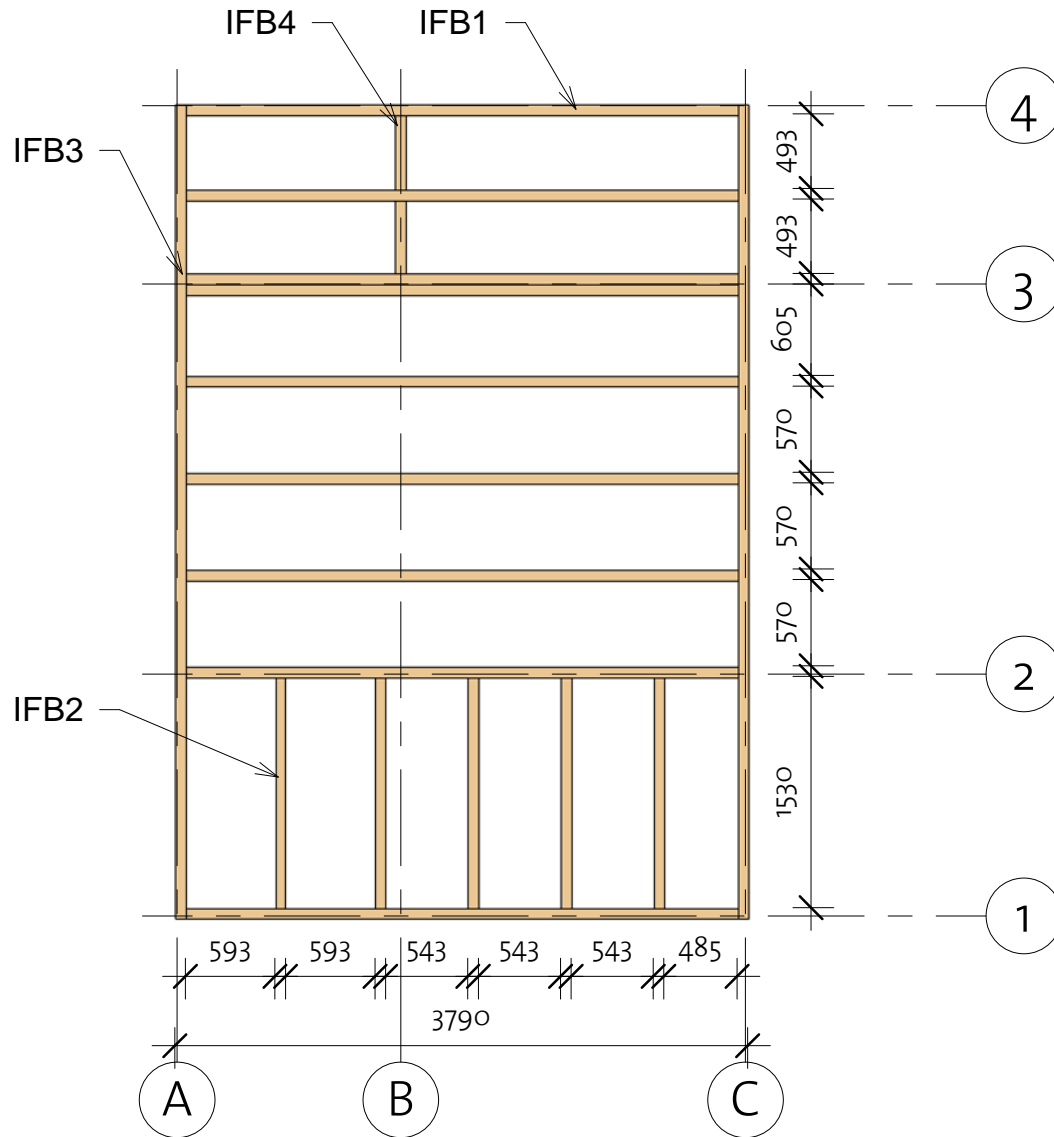

Impregnated foundation beams				
Mark	Type	Profile	Count	Length

IFB1	IFB 70x40		9	3650
IFB2	IFB 70x40		5	1530
IFB3	IFB 70x40		2	5390
IFB4	IFB 70x40		2	493

Johnny 40 (380x380)

Floor Plan

① Baseboard

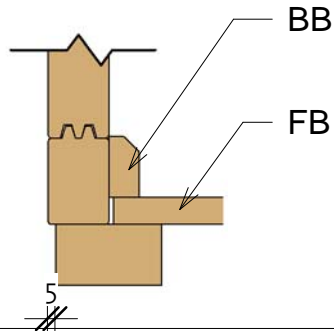

Floor Schedule

Mark	Type	Profile	Count	Length
------	------	---------	-------	--------

FB1	FB 18x110		14	1134
FB2	FB 18x110		15	2534
FB3	FB 18x110		22	3714

BB 1	BB 18x40		4	3800
BB 2	BB 18x40		2	3040

Terrace Schedule

TB	TB 18x95		18	3714
----	----------	--	----	------

91905162_190613

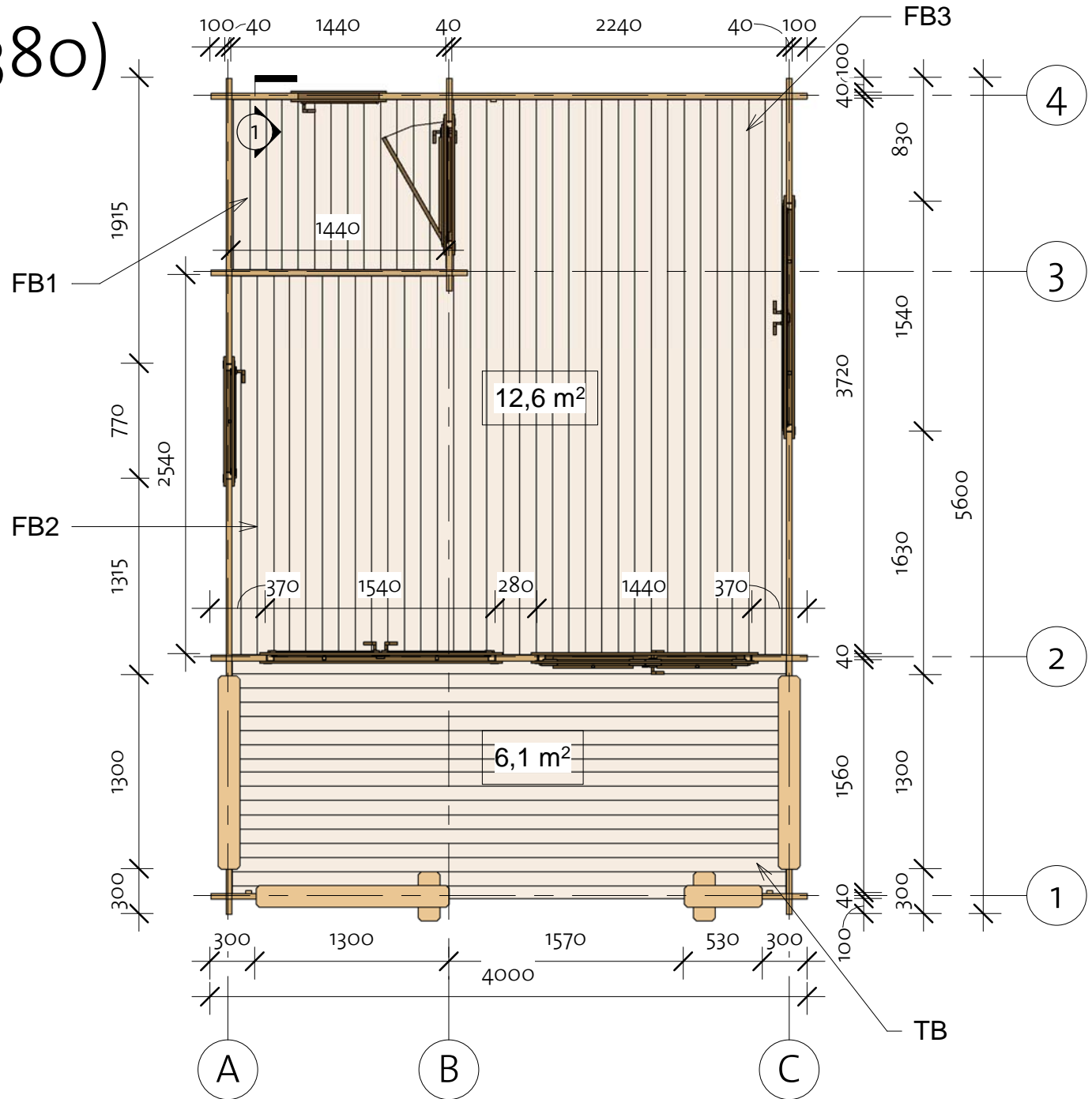

Johnny 40 (380x380)

Wall 1

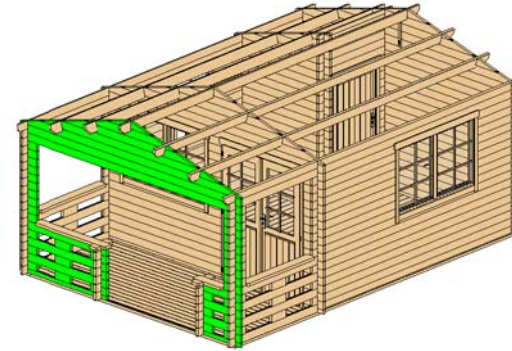

Wall 1			
Mark	Profile	Count	Cut Length

1BL-1	40X57	1	815
1BL-2	40X57	1	1585
1LG-1	40X114	32	300
1LG-2	40X114	2	815
1LG-3 *	40X114	1	828
1LG-4	40X114	2	1585
1LG-5 *	40X114	1	1654
1LG-6 *	40X114	1	2481
1LG-7 *	40X114	1	3307
1LG-8	40X114	2	4000
1LG-9 *	40X114	1	4000
1LG-10	40X114	3	280
1LG-11	40X114	1	1585
1LG-12	40X114	1	815

* Gable - delivered premounted

Log Profile Wall 1	
Profile	Profile

40X57	
40X114	

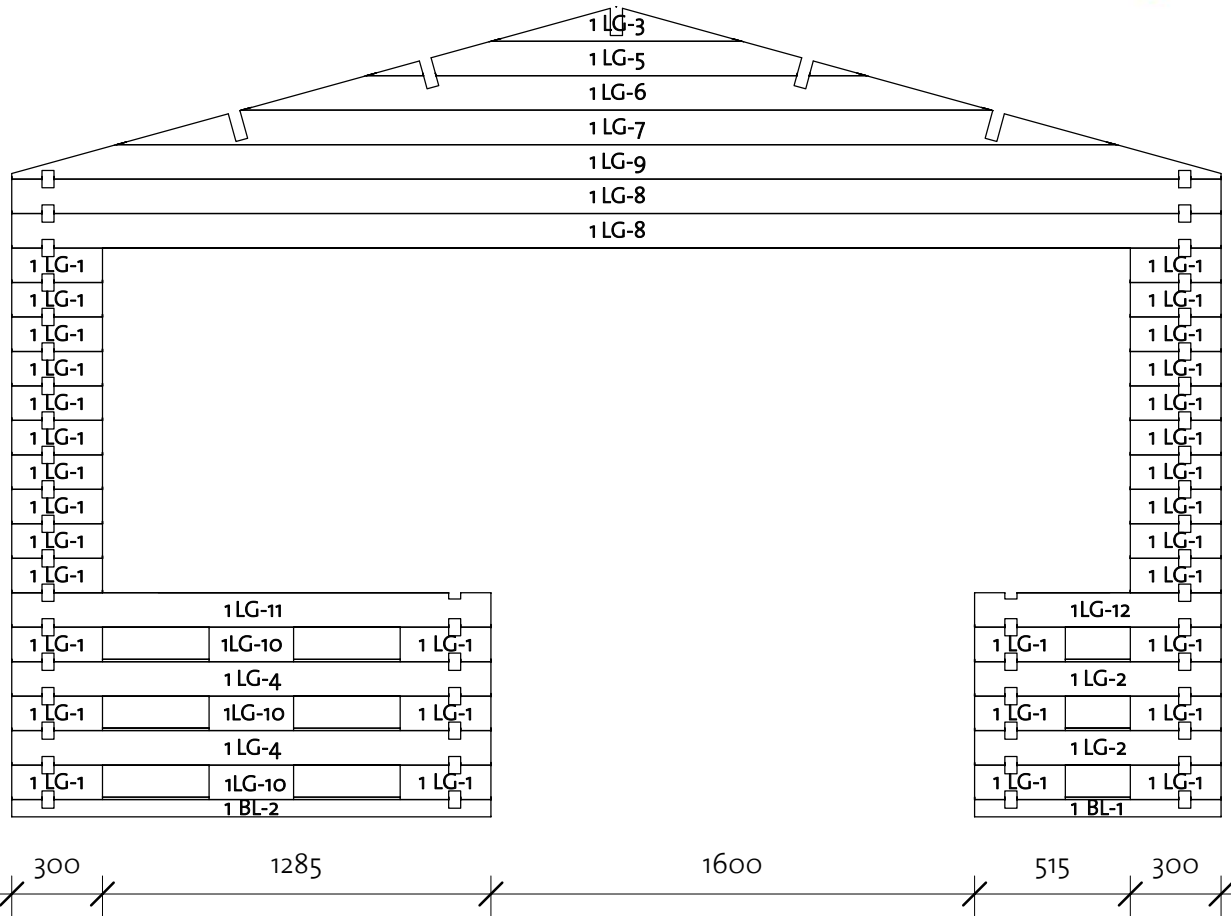

Johnny 40 (380x380)

Wall 2

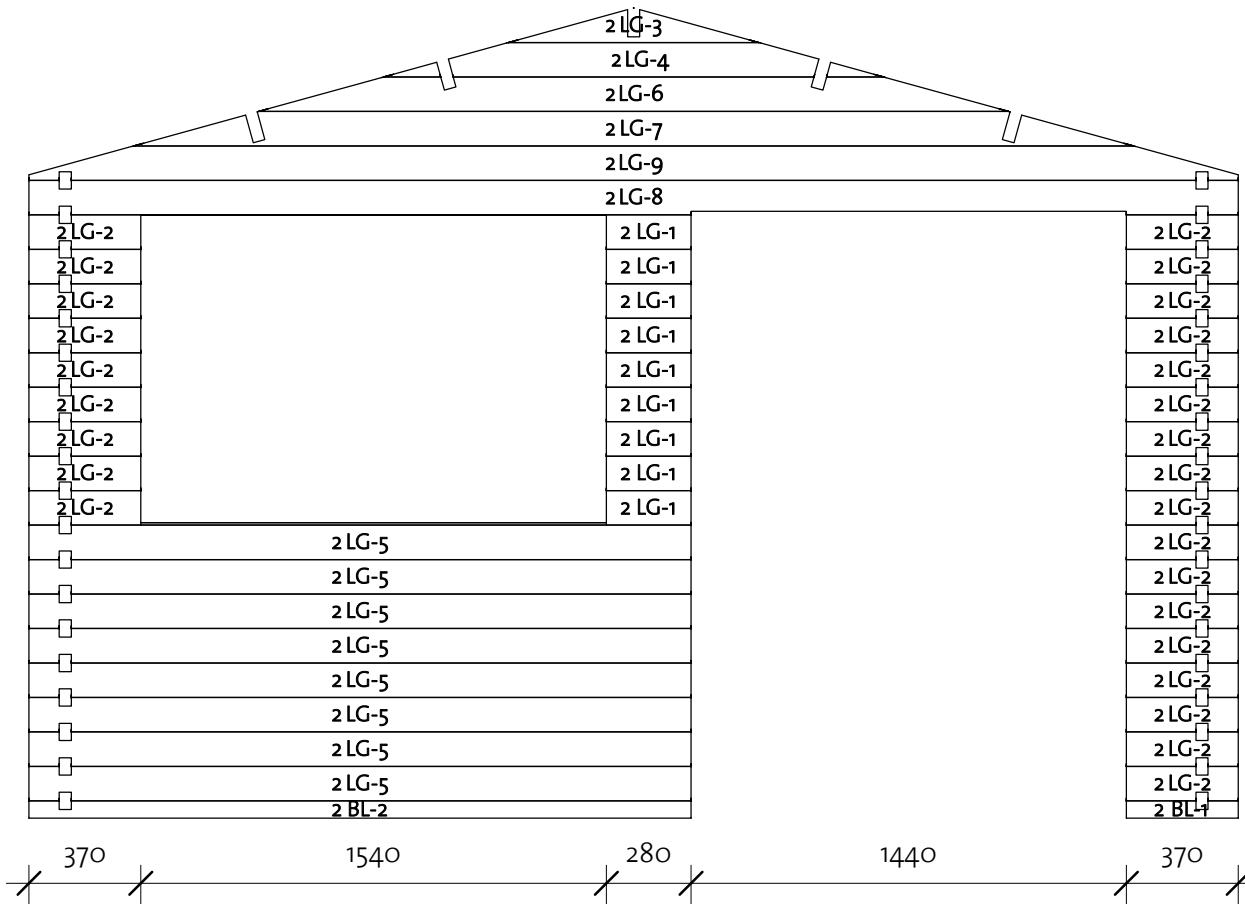
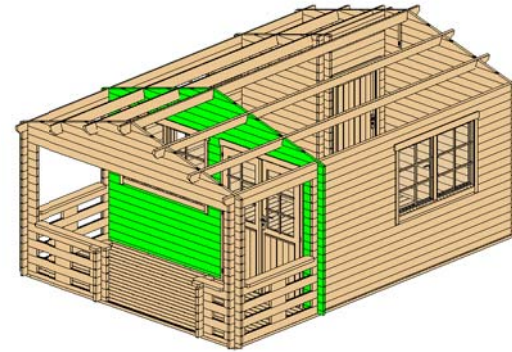



Wall 2			
Mark	Profile	Count	Cut Length

2BL-1	40x57	1	370
2BL-2	40x57	1	2190
2LG-1	40x114	9	280
2LG-2	40x114	26	370
2LG-3*	40x114	1	828
2LG-4*	40x114	1	1654
2LG-5	40x114	8	2190
2LG-6*	40x114	1	2481
2LG-7*	40x114	1	3307
2LG-8	40x114	1	4000
2LG-9*	40x114	1	4000

* Gable - delivered premounted

Log Profile Wall 2	
Profile	Profile

40x57	
40x114	

Johnny 40 (380x380)

Wall 3

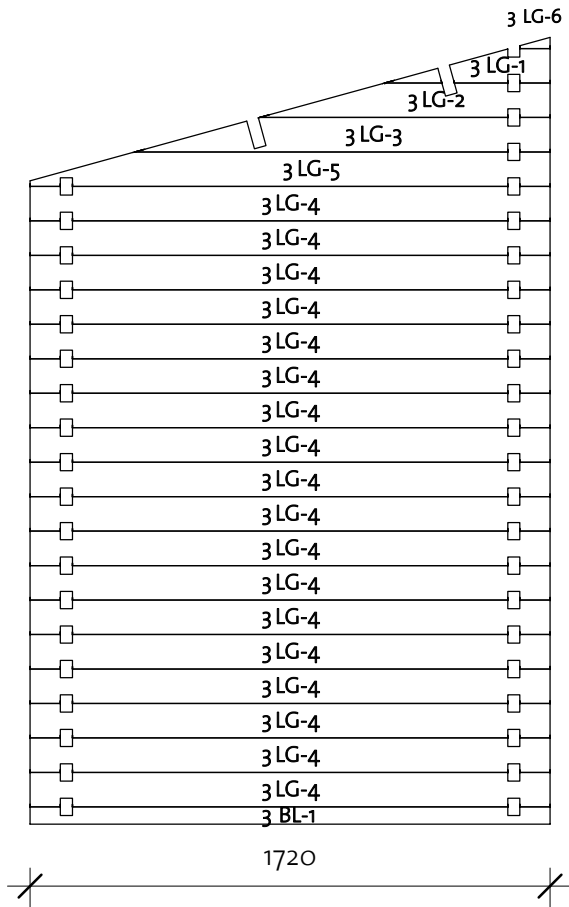
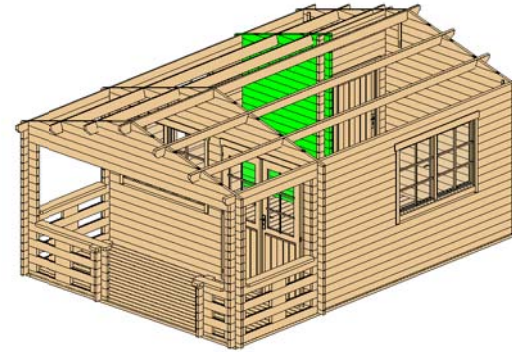

Wall 3			
Mark	Profile	Count	Cut Length

3BL-1	40x57	1	1720
3LG-1	40x114	1	547
3LG-2	40x114	1	960
3LG-3	40x114	1	1373
3LG-4	40x114	18	1720
3LG-5	40x114	1	1720
3LG-6	40x114	1	100

Log Profile Wall 3	
Profile	Profile

40x57	
40x114	

Johnny 40 (380x380)

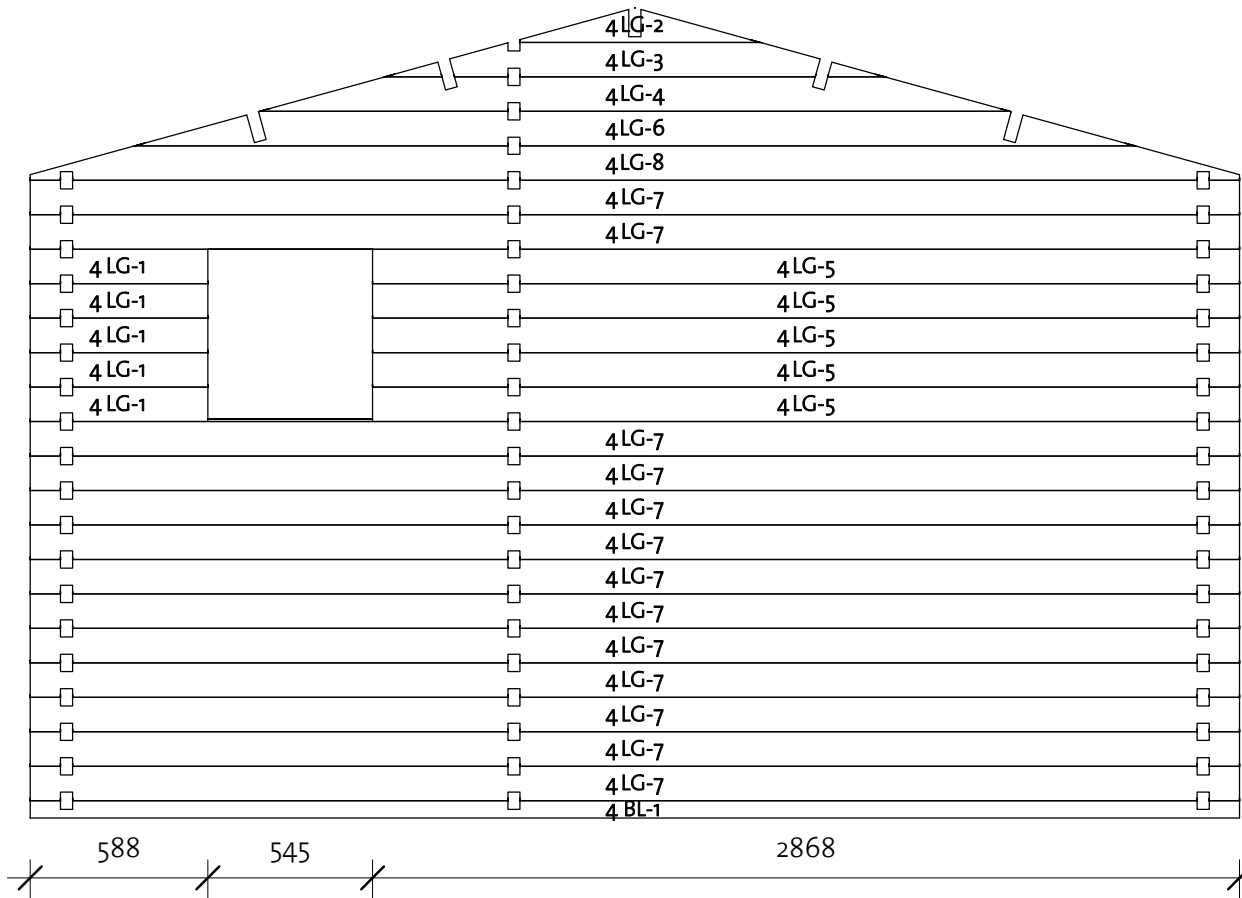
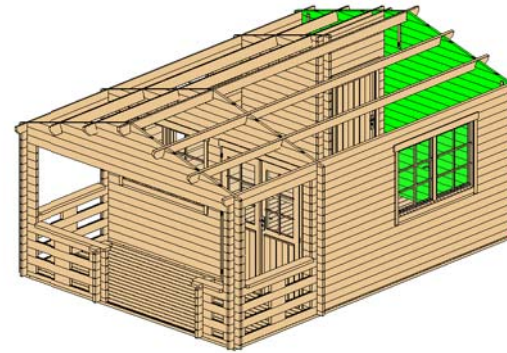

Wall 4



Wall 4			
Mark	Profile	Count	Cut Length

4BL-1	40x57	1	4000
4LG-1	40x114	5	588
4LG-2	40x114	1	794
4LG-3	40x114	1	1654
4LG-4	40x114	1	2481
4LG-5	40x114	5	2868
4LG-6	40x114	1	3307
4LG-7	40x114	13	4000
4LG-8	40x114	1	4000

Log Profile Wall 4	
Profile	Profile

40x57	
40x114	

Johnny 40 (380x380)

Wall A

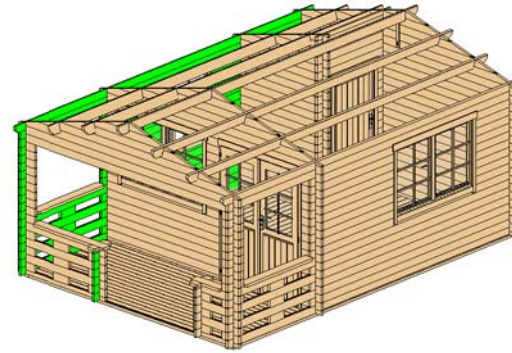

Wall A

Mark	Profile	Count	Cut Length
------	---------	-------	------------

ALG-1	40X114	13	300
ALG-2	40X114	3	280
ALG-3	40X114	9	1315
ALG-4	40X114	9	1915
ALG-5	40X114	4	4000
ALG-6	40X114	4	5600
ALG-7	40X114	1	5600
ATL-1	40X114	1	5800

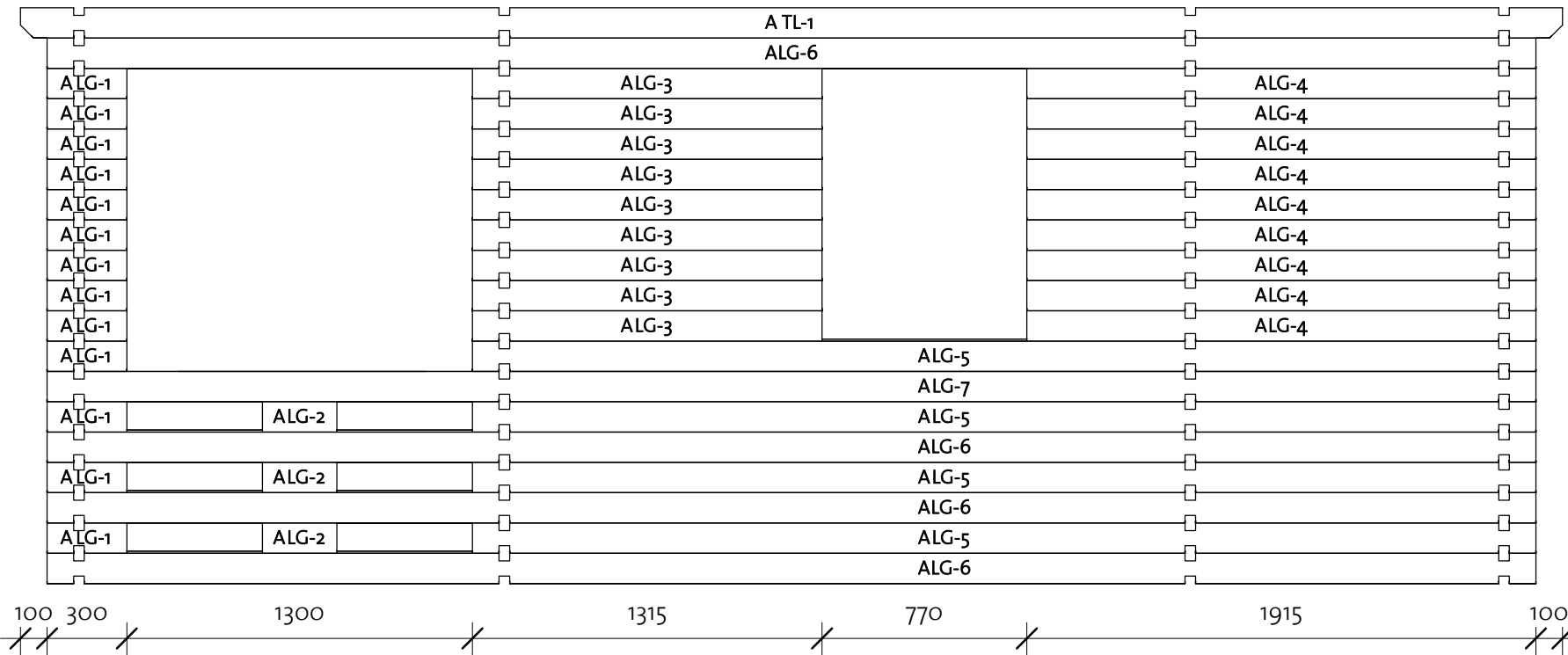

Log Profile Wall A

Profile	Profile
---------	---------

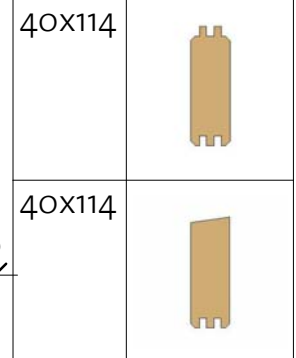

91905162_190606

Johnny 40 (380x380)

Wall B/ Wall AB/ Wall BC

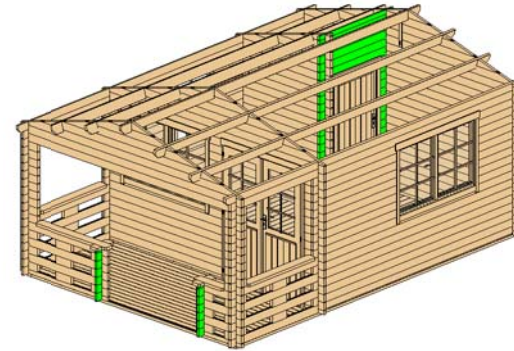

Wall AB			
Mark	Profile	Count	Cut Length

ABLG-1	40x114	6	240
ABTL-1	40x57	1	240

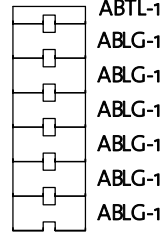

Wall BC			
Mark	Profile	Count	Cut Length

BCLG-1	40x114	6	240
BCTL-1	40x57	1	240

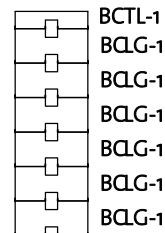

Wall B			
Mark	Profile	Count	Cut Length

BLG-1	40x114	34	285
BLG-2	40x114	4	1420
BLG-3	40x114	1	1420
BTL-1	40x66	1	1420

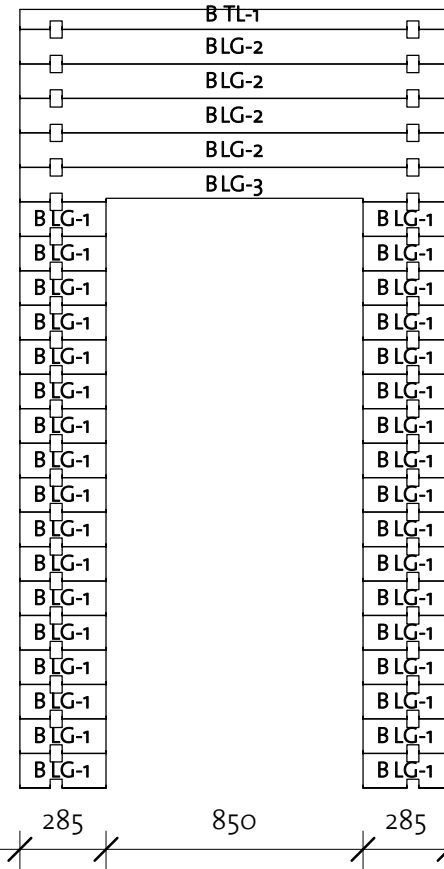

Log Profile Wall B/ AB/ BC	
Profile	Profile

40x114	
40x66	
40x57	

Johnny 40 (380x380)

Wall C

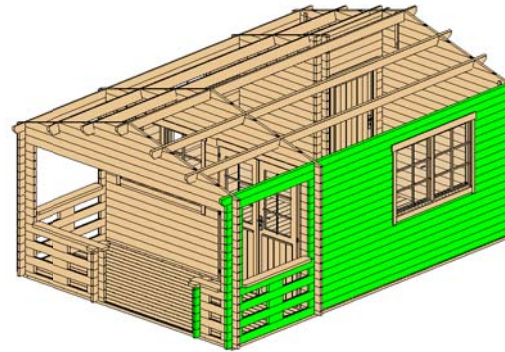

Wall C

Mark	Profile	Count	Cut Length
------	---------	-------	------------

CLG-1	40X114	3	280
CLG-2	40X114	13	300
CLG-3	40X114	9	830
CLG-4	40X114	9	1630
CLG-5	40X114	4	4000
CLG-6	40X114	4	5600
CLG-7	40X114	1	5600
CTL-1	40X114	1	5800

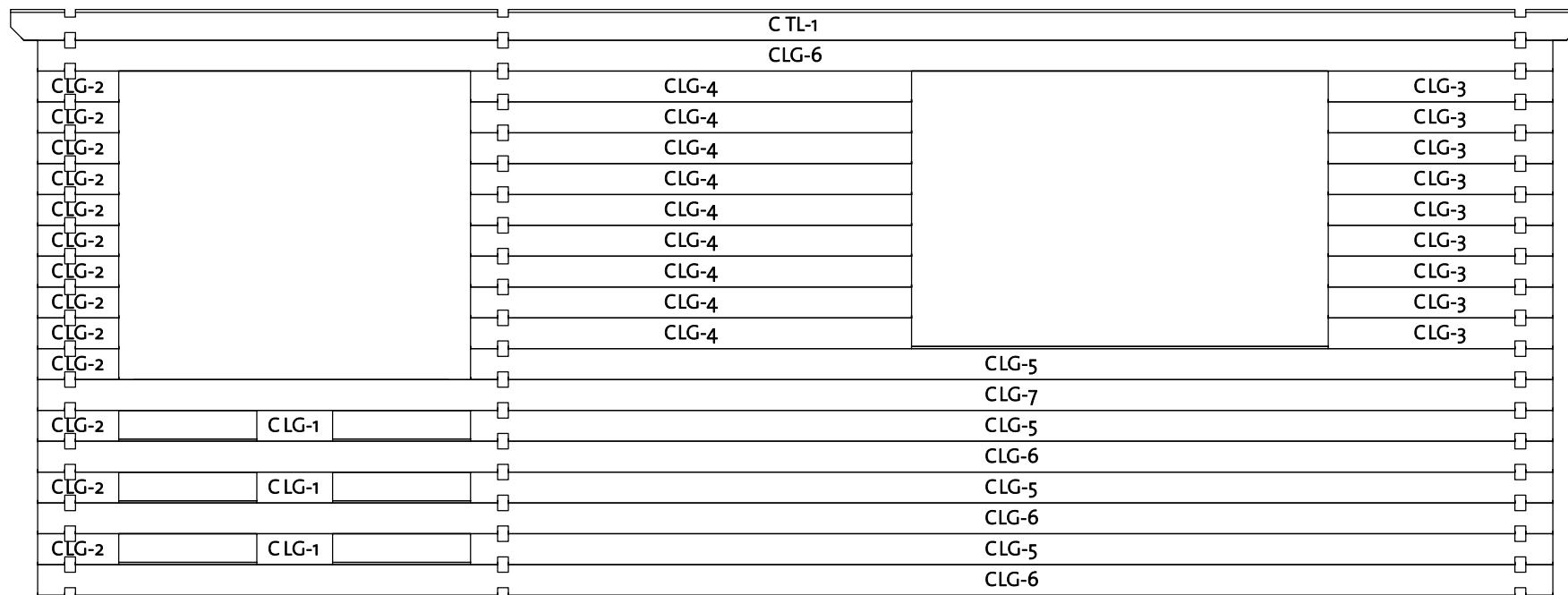

Log Profile Wall C

Profile	Profile
---------	---------

40X114	
40X114	

91905162_190606

Johnny 40 (380x380)

Roof 1

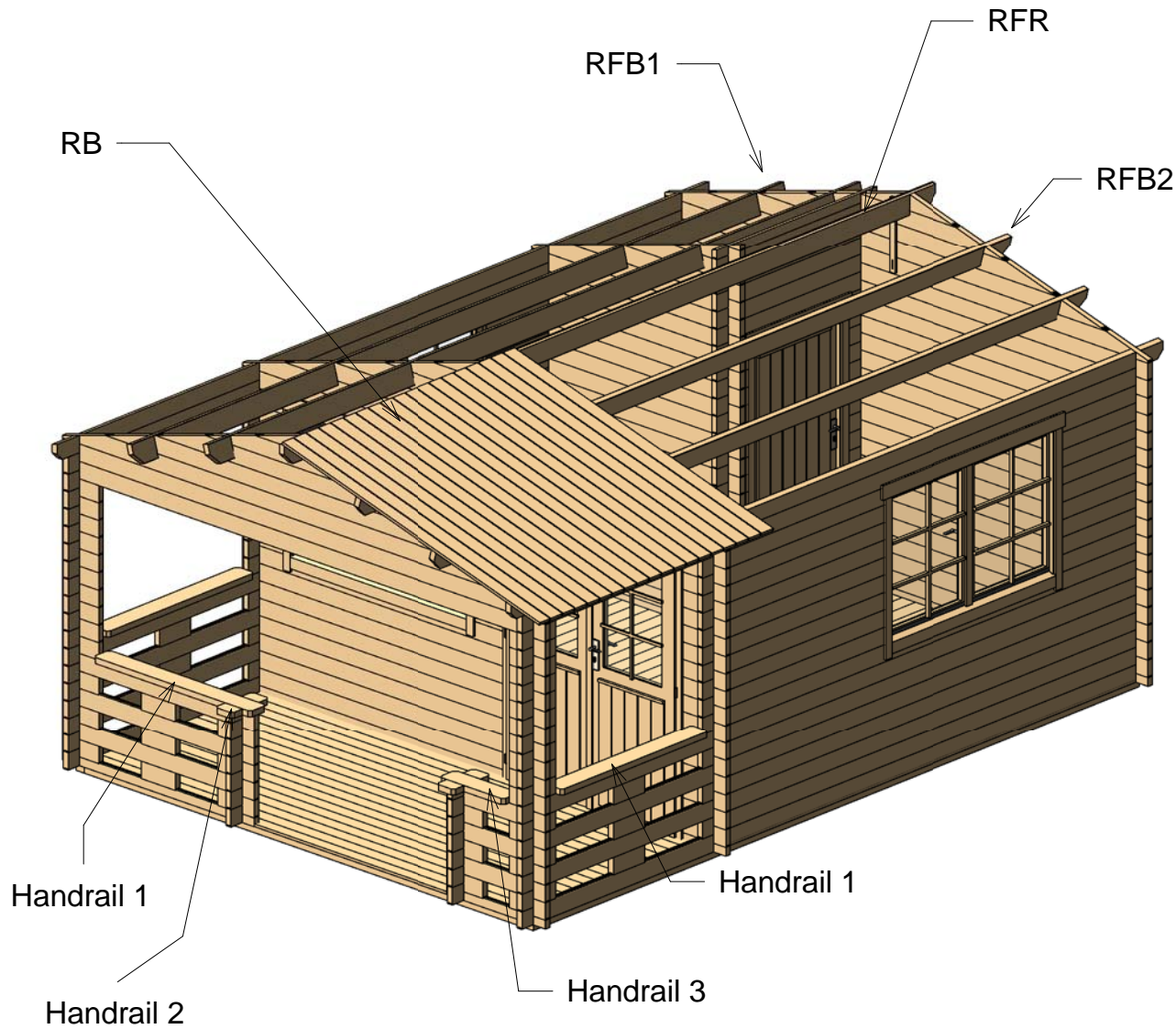

91905162_190607

Roof				
Mark	Type	Profile	Count	Length

RB	18x110		108	2215
RFB1	Beam 40x143		2	5800
RFB2	Beam 40x143		2	5800
RFR	Ridge 40x143		1	5800

Type	Profile	Count	Length
------	---------	-------	--------

Handrail 1	40x143	3	1300
Handrail 2	40x143	4	94
Handrail 3	40x143	1	530



Johnny 40 (380x380)

Roof 2

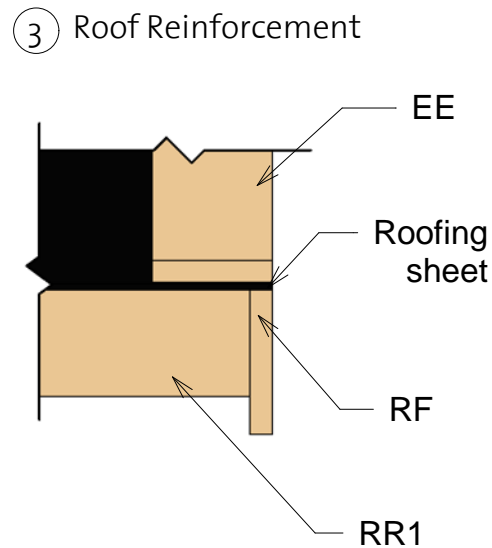
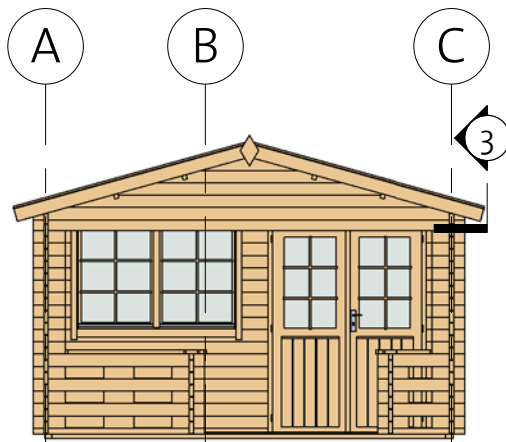
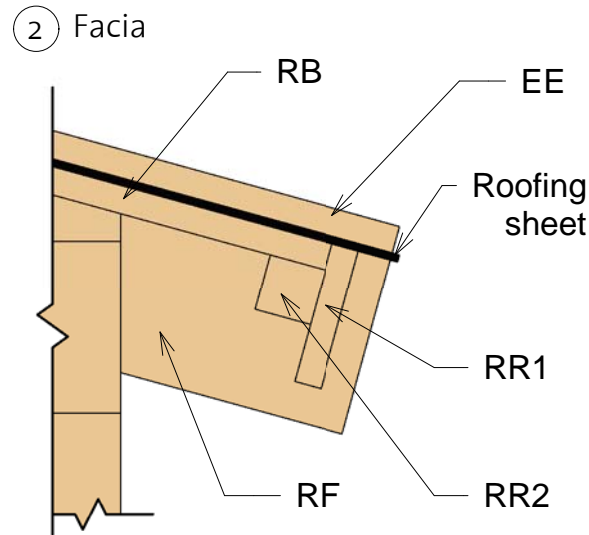
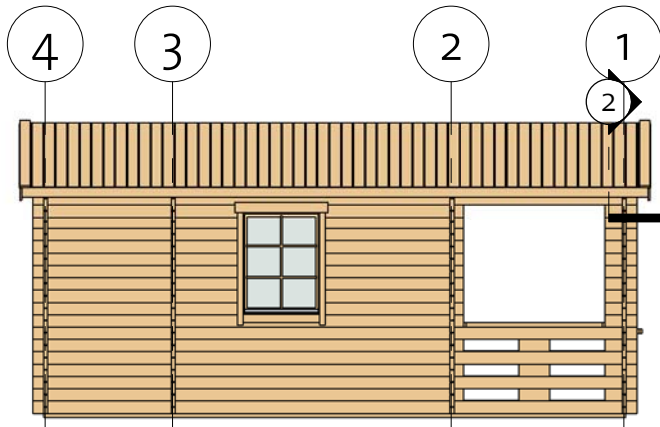

Fascia Schedule				
Mark	Type	Profile	Count	Length
EE	Eave Edging 18x95		4	2260
RF	Roof Fascia 18x120		4	2260
RR1	Roof reinforcement 18x95		2	5800
RR2	Roof reinforcement 38x38		2	5800

Johnny 40 (380x380)

Extras

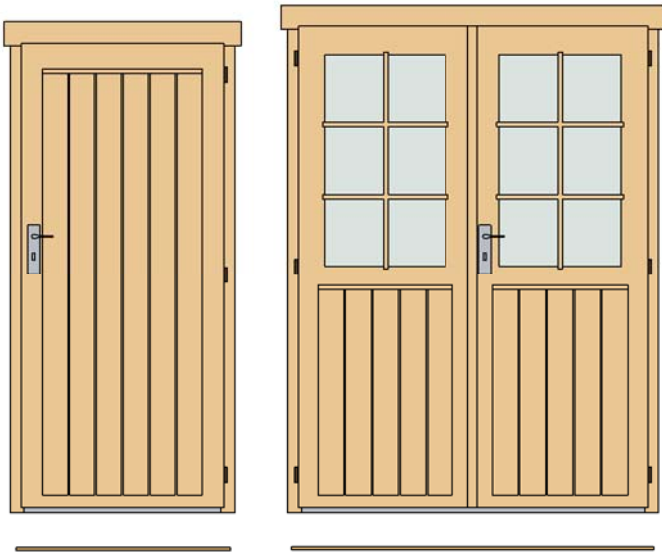

Fasteners/Extras		
Name	Type	Count

Hitblock	300-400 mm	
Bolts	M8x70	20
Screws	5,0 x 70	25
Nails	1,4 x 40	90
Screws	6,0 x 140	120
Screws	4,0 x 40	120
Screws	4,0 x 50	1000

Door Schedule				
Model	Type	Width	Height	Count

CD5R	Classic door 5, wood right	840	1890	1
CDD1R	Classic double door 1 right	1425	1955	1

DCB6	Door Crossbar 6	--	--	2
------	-----------------	----	----	---

DB	Door beam 1440 mm	40	12	1
----	-------------------	----	----	---

DB	Door beam 850 mm	40	12	1
----	------------------	----	----	---

Window Schedule				
Mark	Type	Width	Height	Count

CDW1	Classic double window 1	1530	990	2
CW1L	Classic window 1 left	765	990	1
CW12R	Classic window 12, full glass right	540	540	1

WCB6	Windows Crossbar 6	--	--	5
------	--------------------	----	----	---

Type	Count	Length
------	-------	--------

Windboard 18x40	7	2200
-----------------	---	------

Type	Count
------	-------



Romb	2
------	---

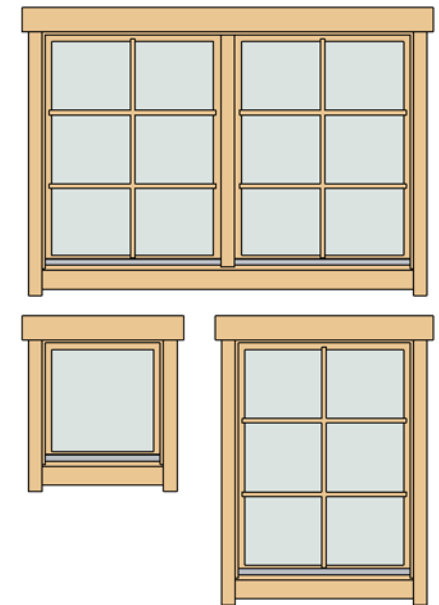





Johnny 40 (380x380)

List of all items 1

Impregnated foundation beams

Mark	Type	Profile	Count	Length
IFB1	IFB 70x40		9	3650
IFB2	IFB 70x40		5	1530
IFB3	IFB 70x40		2	5390
IFB4	IFB 70x40		2	493

Roof

Mark	Type	Profile	Count	Length
RB	18x110		108	2215
RFB1	Beam 40x143		2	5800
RFB2	Beam 40x143		2	5800
RFR	Ridge 40x143		1	5800

Floor Schedule





Mark	Type	Profile	Count	Length
FB1	FB 18x110		14	1134
FB2	FB 18x110		15	2534
FB3	FB 18x110		22	3714

BB 1	BB 18x40		4	3800
BB 2	BB 18x40		2	3040

Terrace Schedule

TB	TB 18x95		18	3714
----	----------	--	----	------

Fascia Schedule

Mark	Type	Profile	Count	Length
EE	Eave Edging 18x95		4	2260
RF	Roof Fascia 18x120		4	2260
RR1	Roof reinforce ment 18x95		2	5800
RR2	Roof reinforce ment 38x38		2	5800

Johnny 40 (380x380)

List of all items 2

Wall 1			
Mark	Profile	Count	Cut Length

1BL-1	40X57	1	815
1BL-2	40X57	1	1585
1LG-1	40X114	32	300
1LG-2	40X114	2	815
1LG-3 *	40X114	1	828
1LG-4	40X114	2	1585
1LG-5 *	40X114	1	1654
1LG-6 *	40X114	1	2481
1LG-7 *	40X114	1	3307
1LG-8	40X114	2	4000
1LG-9 *	40X114	1	4000
1LG-10	40X114	3	280
1LG-11	40X114	1	1585
1LG-12	40X114	1	815

Wall 3			
Mark	Profile	Count	Cut Length

3BL-1	40X57	1	1720
3LG-1	40X114	1	547
3LG-2	40X114	1	960
3LG-3	40X114	1	1373
3LG-4	40X114	18	1720
3LG-5	40X114	1	1720
3LG-6	40X114	1	100

Wall AB			
Mark	Profile	Count	Cut Length

ABLG-1	40X114	6	240
ABTL-1	40X57	1	240

Wall 2			
Mark	Profile	Count	Cut Length

2BL-1	40X57	1	370
2BL-2	40X57	1	2190
2LG-1	40X114	9	280
2LG-2	40X114	26	370
2LG-3 *	40X114	1	828
2LG-4 *	40X114	1	1654
2LG-5	40X114	8	2190
2LG-6 *	40X114	1	2481
2LG-7 *	40X114	1	3307
2LG-8	40X114	1	4000
2LG-9 *	40X114	1	4000

* Gable - delivered premounted

Wall 4			
Mark	Profile	Count	Cut Length

4BL-1	40X57	1	4000
4LG-1	40X114	5	588
4LG-2	40X114	1	794
4LG-3	40X114	1	1654
4LG-4	40X114	1	2481
4LG-5	40X114	5	2868
4LG-6	40X114	1	3307
4LG-7	40X114	13	4000
4LG-8	40X114	1	4000

Johnny 40 (380x380)

List of all items 3

Wall A			
Mark	Profile	Count	Cut Length

ALG-1	40X114	13	300
ALG-2	40X114	3	280
ALG-3	40X114	9	1315
ALG-4	40X114	9	1915
ALG-5	40X114	4	4000
ALG-6	40X114	4	5600
ALG-7	40X114	1	5600
ATL-1	40X114	1	5800

Wall B			
Mark	Profile	Count	Cut Length

BLG-1	40X114	34	285
BLG-2	40X114	4	1420
BLG-3	40X114	1	1420
BTL-1	40X66	1	1420



Wall BC			
Mark	Profile	Count	Cut Length

BCLG-1	40X114	6	240
BCTL-1	40X57	1	240

Wall C			
Mark	Profile	Count	Cut Length

CLG-1	40X114	3	280
CLG-2	40X114	13	300
CLG-3	40X114	9	830
CLG-4	40X114	9	1630
CLG-5	40X114	4	4000
CLG-6	40X114	4	5600
CLG-7	40X114	1	5600
CTL-1	40X114	1	5800

Log profiles	
Profile	Profile

40X57	
40X114	

Log profiles	
Profile	Profile

40X57	
40X66	

Log profiles	
Profile	Profile

40X114	
40X114	