

Johnny 40 (480x480)

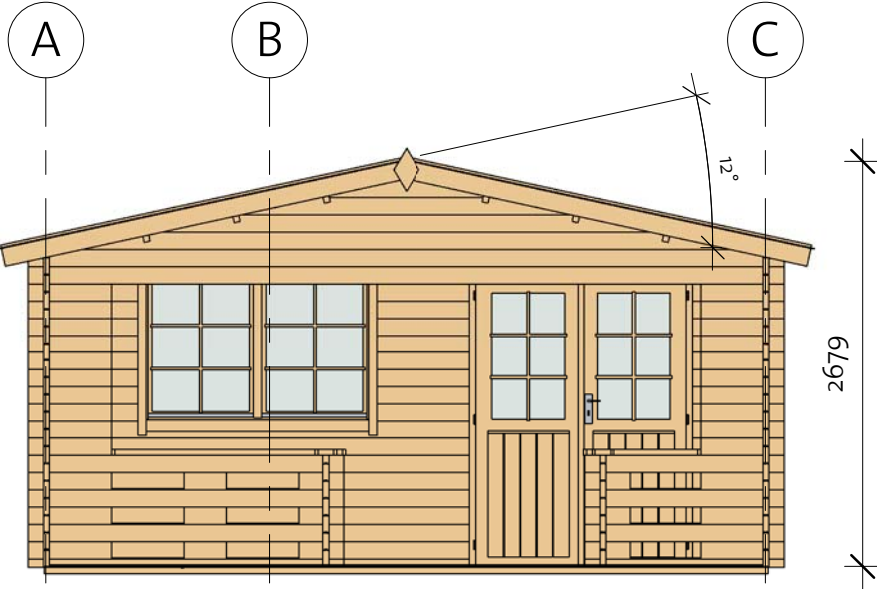

Johnny 40 (480x480)

Foundation

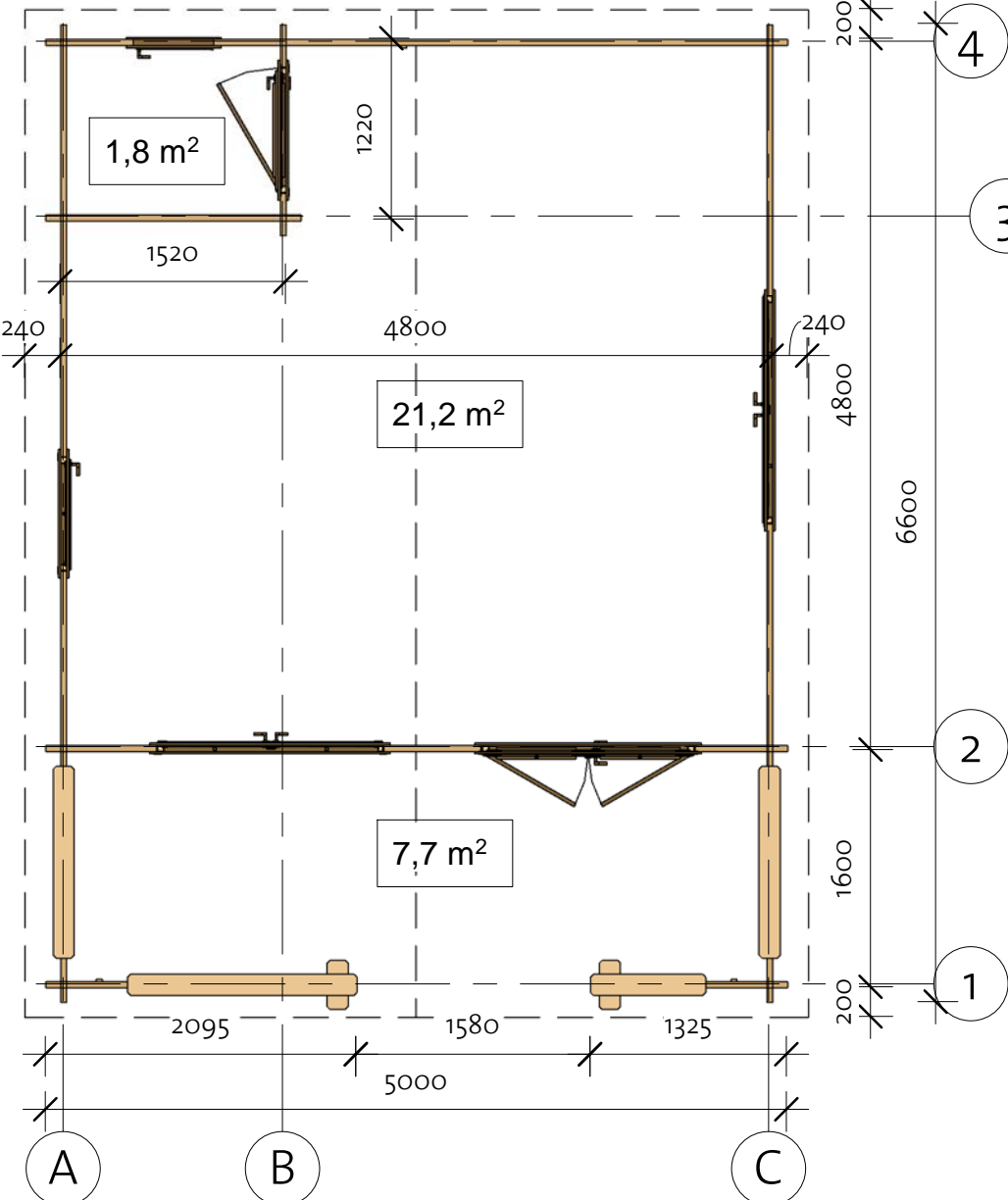
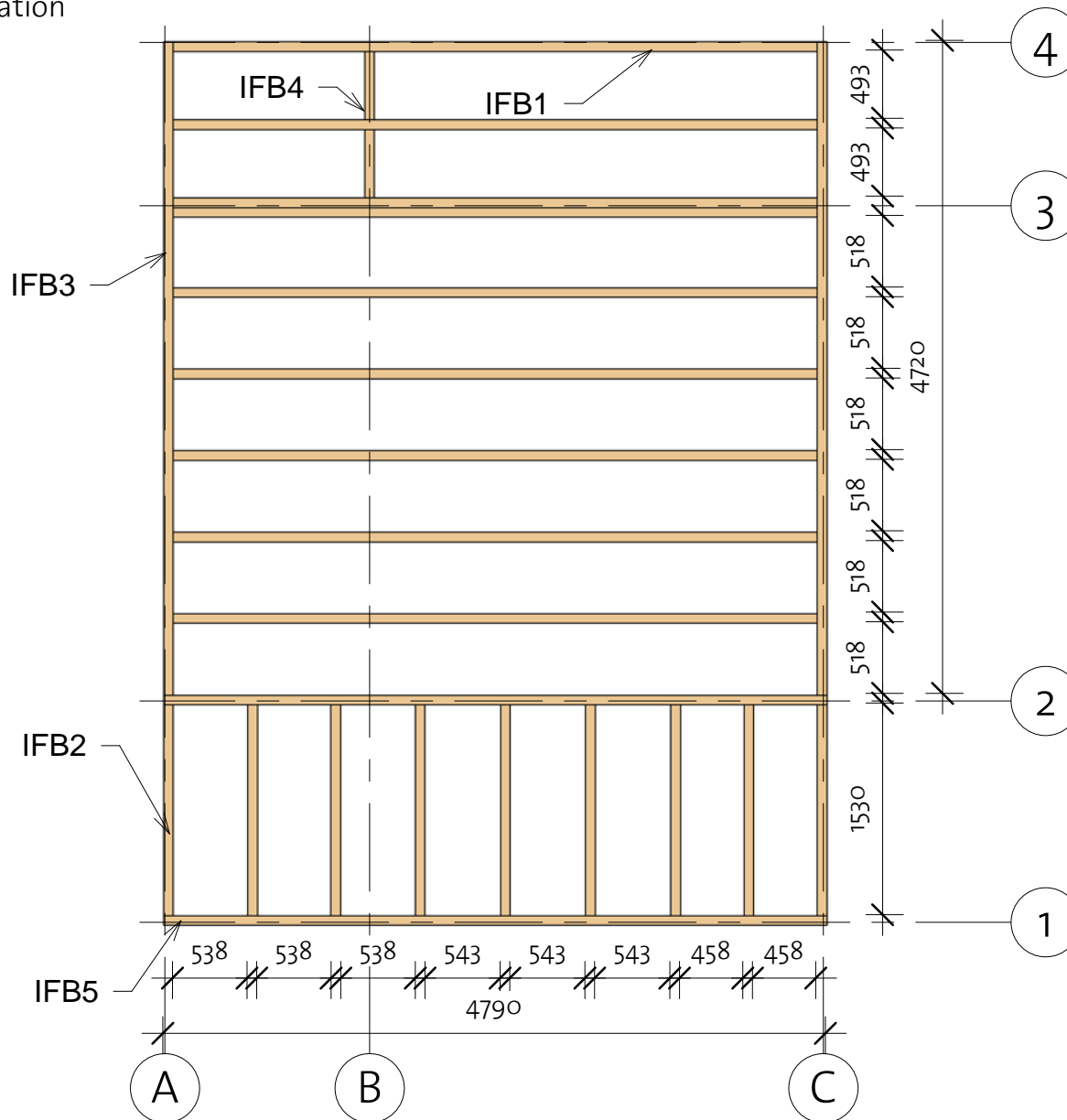

Impregnated foundation beams				
Mark	Type	Profile	Count	Length

IFB1	IFB 70x40		9	4650
IFB2	IFB 70x40		9	1530
IFB3	IFB 70x40		2	4720
IFB4	IFB 70x40		2	493
IFB5	IFB 70x40		2	4790

Johnny 40 (480x480)

Floor Plan

Floor Schedule

Mark	Type	Profile	Count	Length
------	------	---------	-------	--------

FB1	FB 18x110		14	1134
FB2	FB 18x110		15	3534
FB3	FB 18x110		31	4714

BB 1	BB 18x40		4	4800
BB 2	BB 18x40		2	3040

Terrace Schedule

Mark	Type	Profile	Count	Length
------	------	---------	-------	--------

TB	TB 18x95		18	4714
----	----------	---	----	------

① Baseboard

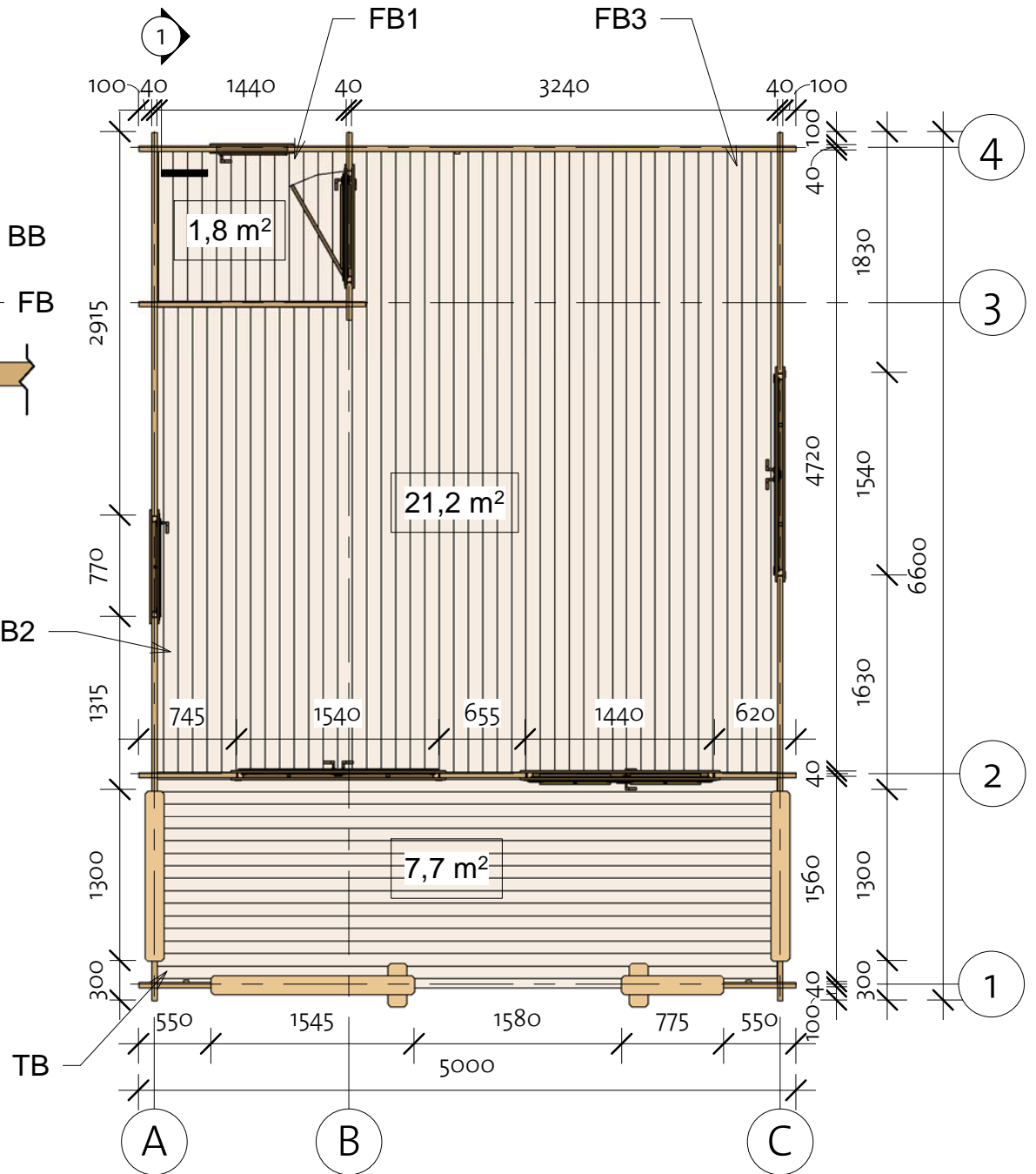
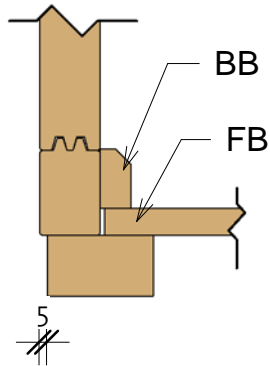

Johnny 40 (480x480)

Wall 1

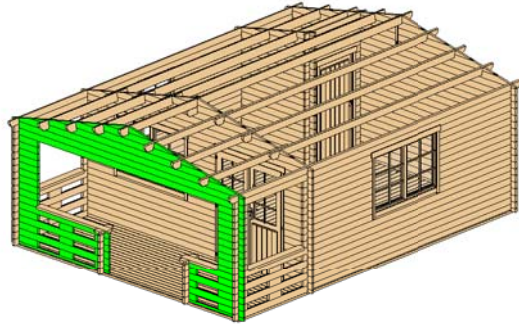

Log Profile Wall 1	
Profile	Profile

40x57	
-------	---

Log Profile Wall 1	
Profile	Profile

40x114	
--------	---

Wall 1			
Mark	Profile	Count	Cut Length

1BL-1	40x57	1	1315
1BL-2	40x57	1	2085
1LG-1	40x114	6	300
1LG-2	40x114	26	550
1LG-3	40x114	3	280
1LG-4 *	40x114	1	1050
1LG-5	40x114	2	1315
1LG-6	40x114	1	1315
1LG-7	40x114	2	2085
1LG-8	40x114	1	2085
1LG-9 *	40x114	1	2099
1LG-10 *	40x114	1	3147
1LG-11 *	40x114	1	4196
1LG-12	40x114	2	5000
1LG-13 *	40x114	1	5000

* Gable - delivered premounted

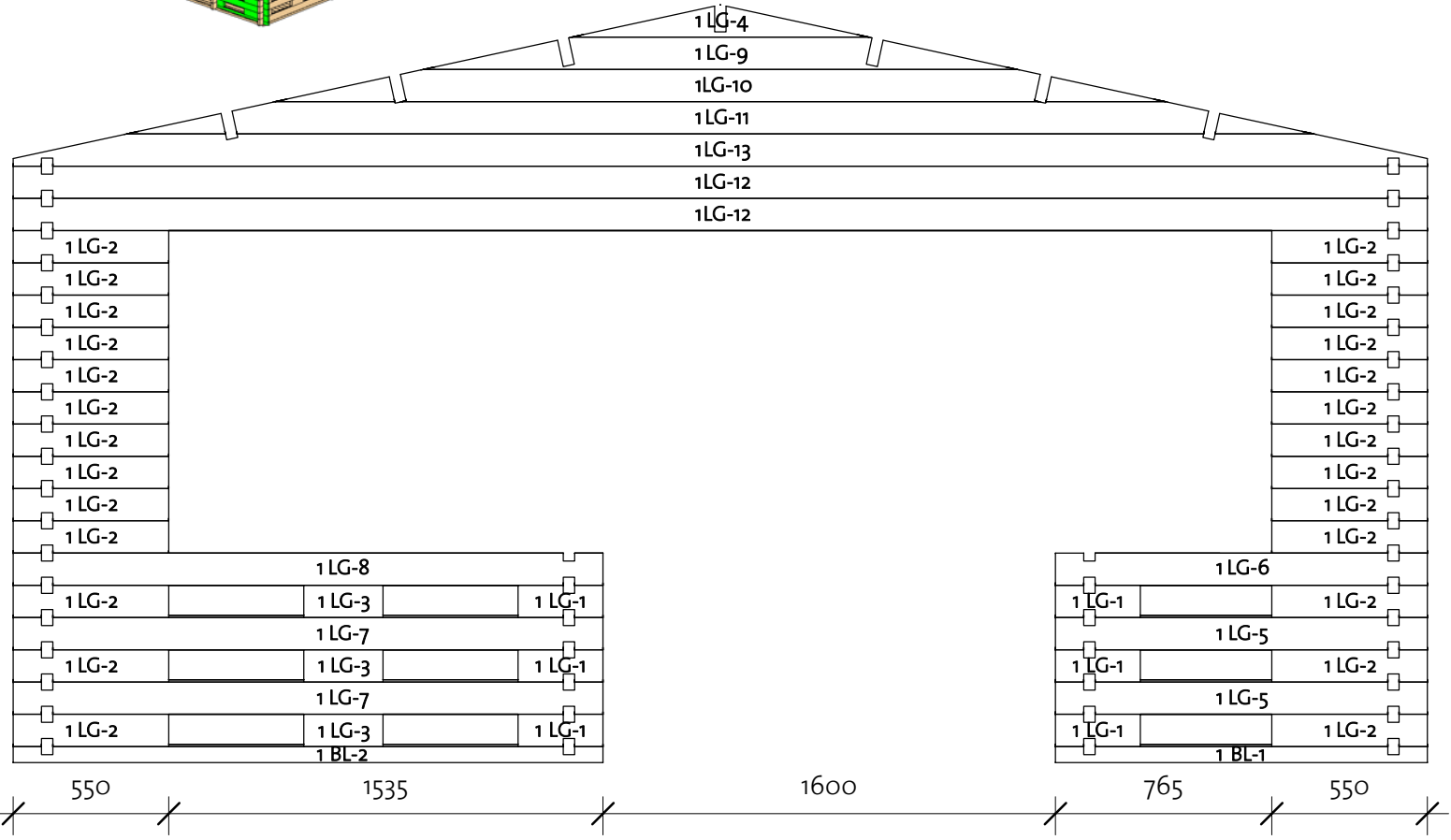



91905163_190612

Johnny 40 (480x480)

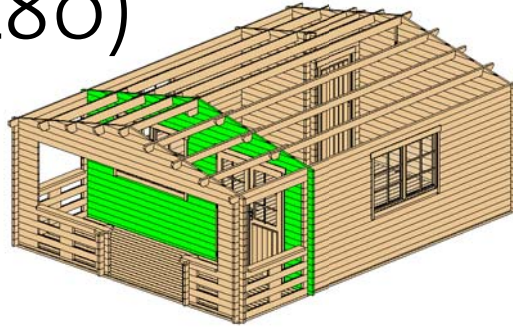
Wall 2



Log Profile Wall 2	
Profile	Profile

40x57	
40x114	

Wall 2			
Mark	Profile	Count	Cut Length

2BL-1	40x57	1	620
2BL-2	40x57	1	2940
2LG-1	40x114	17	620
2LG-2	40x114	9	655
2LG-3	40x114	9	745
2LG-4*	40x114	1	1050
2LG-5*	40x114	1	2099
2LG-6	40x114	8	2940
2LG-7*	40x114	1	3147
2LG-8*	40x114	1	4196
2LG-9*	40x114	1	5000
2LG-10	40x114	1	5000

* Gable - delivered premounted

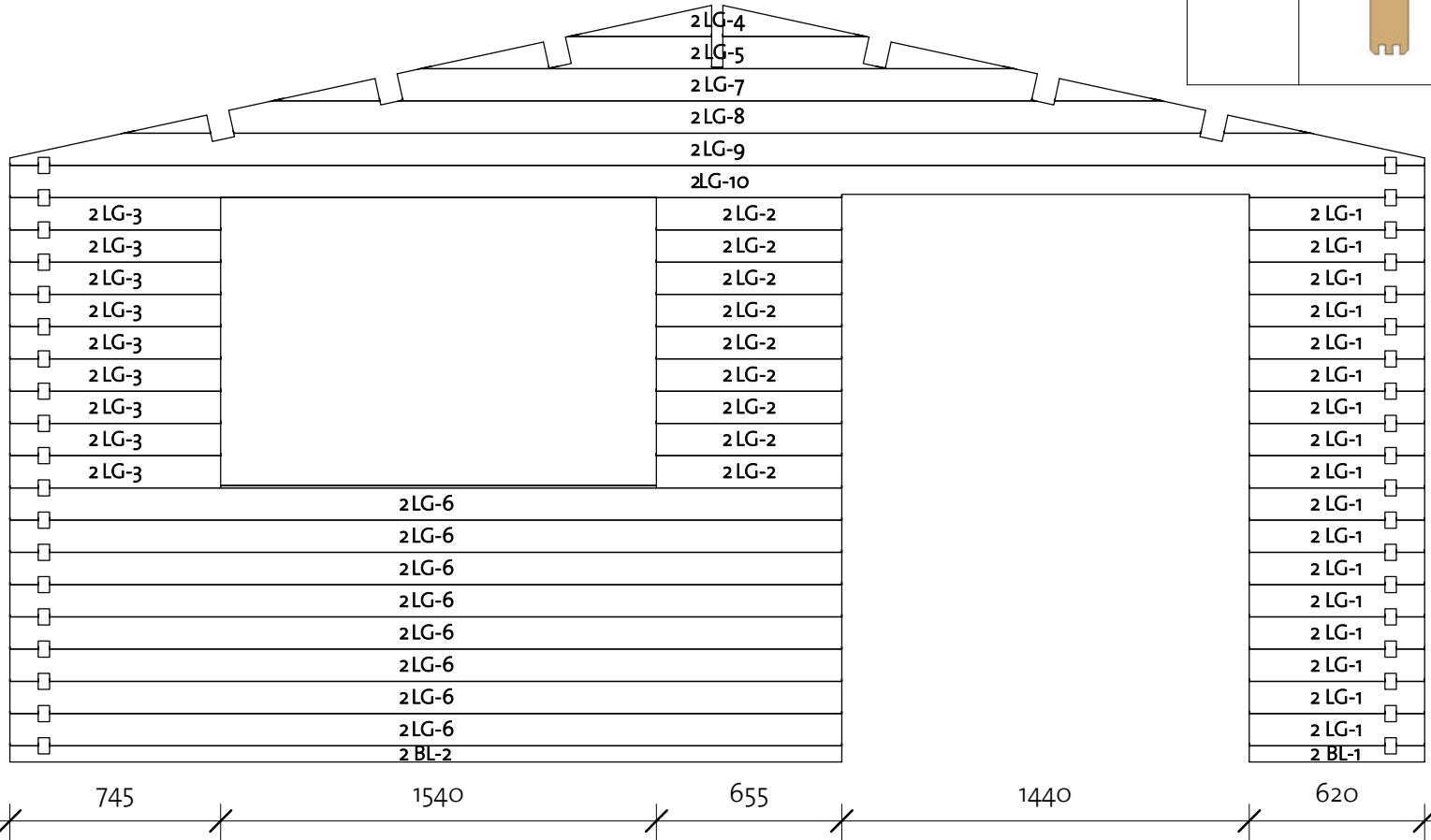

91905163_190612

Johnny 40 (480x480)

Wall 3

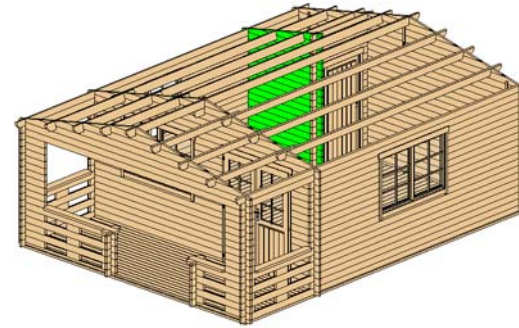

Wall 3			
Mark	Profile	Count	Cut Length

3BL-1	40x57	1	1720
3LG-1	40x114	1	794
3LG-2	40x114	1	1318
3LG-3	40x114	18	1720
3LG-4	40x114	1	1720
3LG-5	40x114	1	269

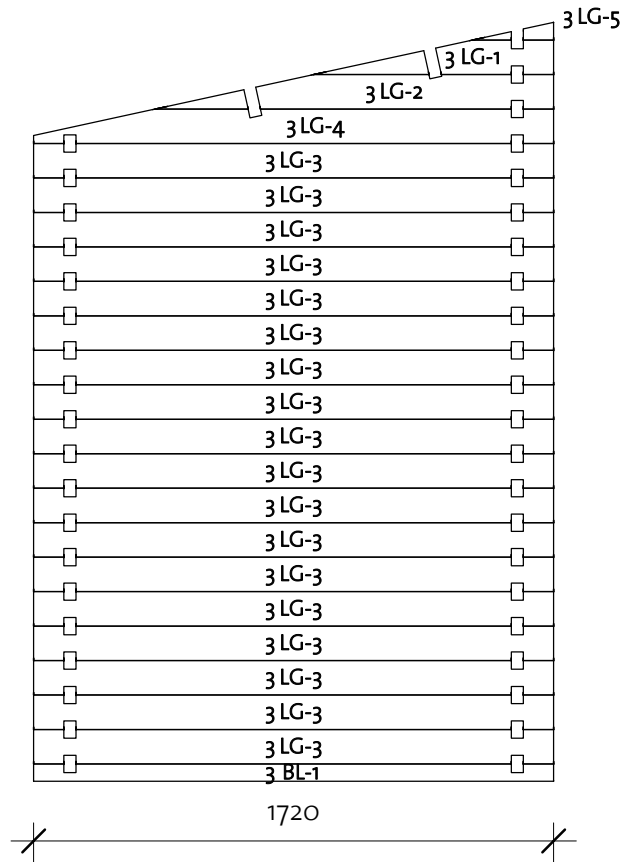

Log Profile Wall 3	
Profile	Profile

40x57	
40x114	

Johnny 40 (480x480)

Wall 4

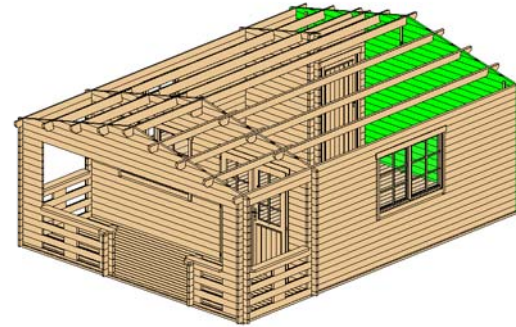

Wall 4			
Mark	Profile	Count	Cut Length

4BL-1	40x57	1	5000
4LG-1	40x114	5	588
4LG-2	40x114	1	1050
4LG-3	40x114	1	2099
4LG-4	40x114	1	3147
4LG-5	40x114	5	3868
4LG-6	40x114	1	4196
4LG-7	40x114	13	5000
4LG-8	40x114	1	5000

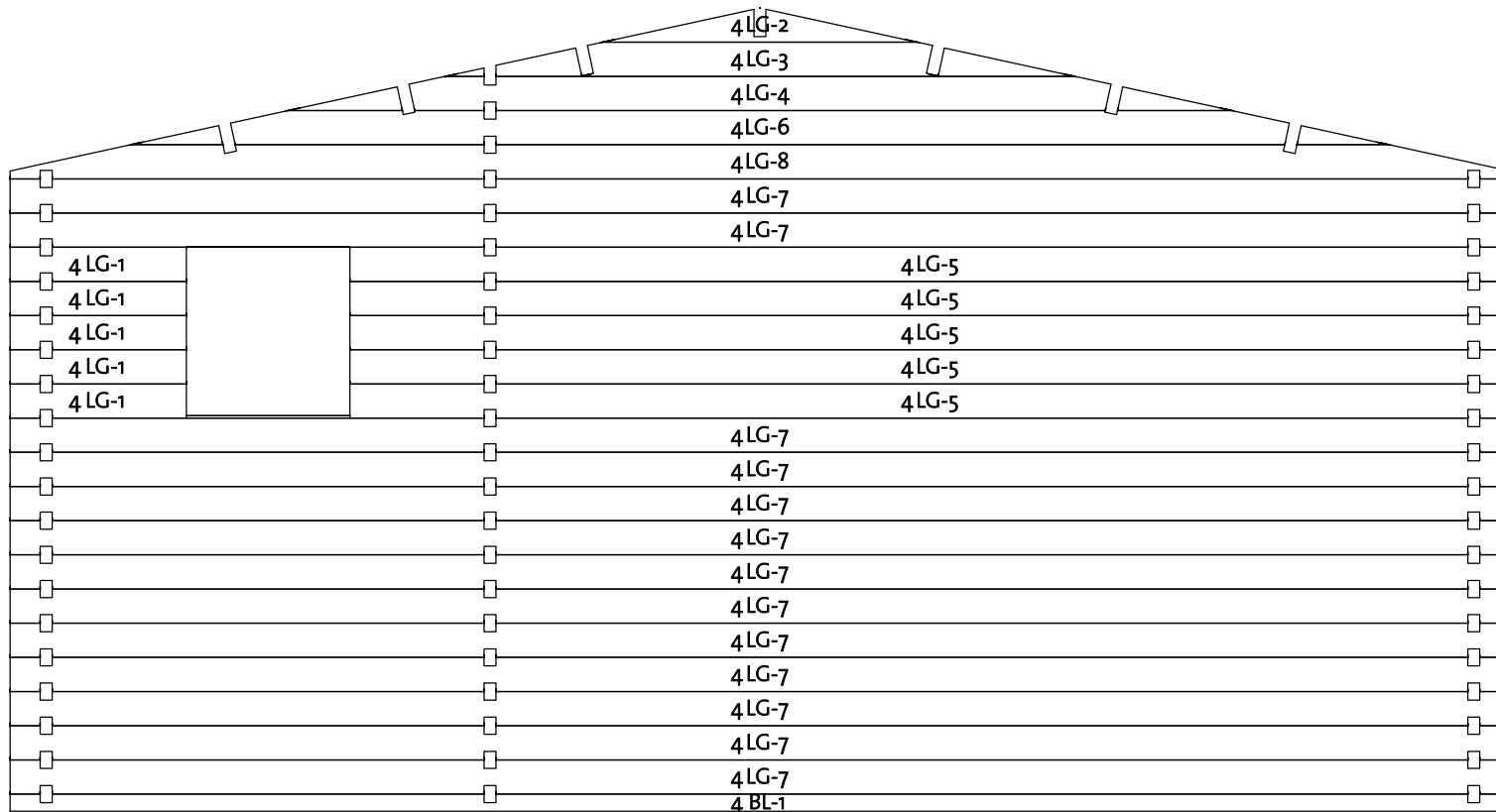

91905163_190612

Log Profile Wall 4	
Profile	Profile

40x57	
40x114	

Johnny 40 (480x480)

Wall A

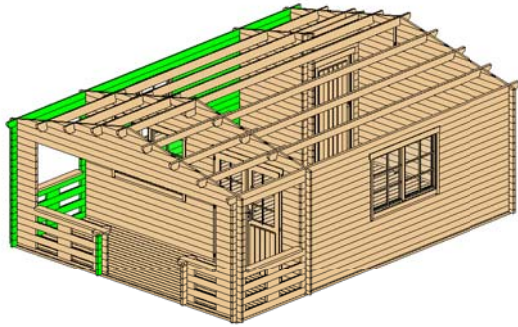

Log Profile Wall A

Profile	Profile
---------	---------

40x114



Log Profile Wall A

Profile	Profile
---------	---------

40x114



Wall A			
Mark	Profile	Count	Cut Length
ALG-1	40x114	13	300
ALG-2	40x114	3	280
ALG-3	40x114	8	1315
ALG-4	40x114	9	2915
ALG-5	40x114	4	5000
ALG-6	40x114	5	4880

Wall A			
Mark	Profile	Count	Cut Length
ALG-7	40x114	4	1720
ALG-8	40x114	1	1315
ALG-9	40x114	1	1720
ATL-1	40x114	1	1820
ATL-2	40x114	1	4980

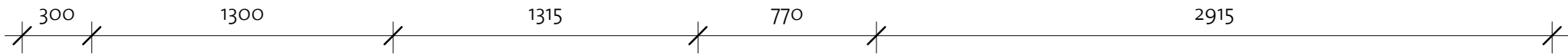
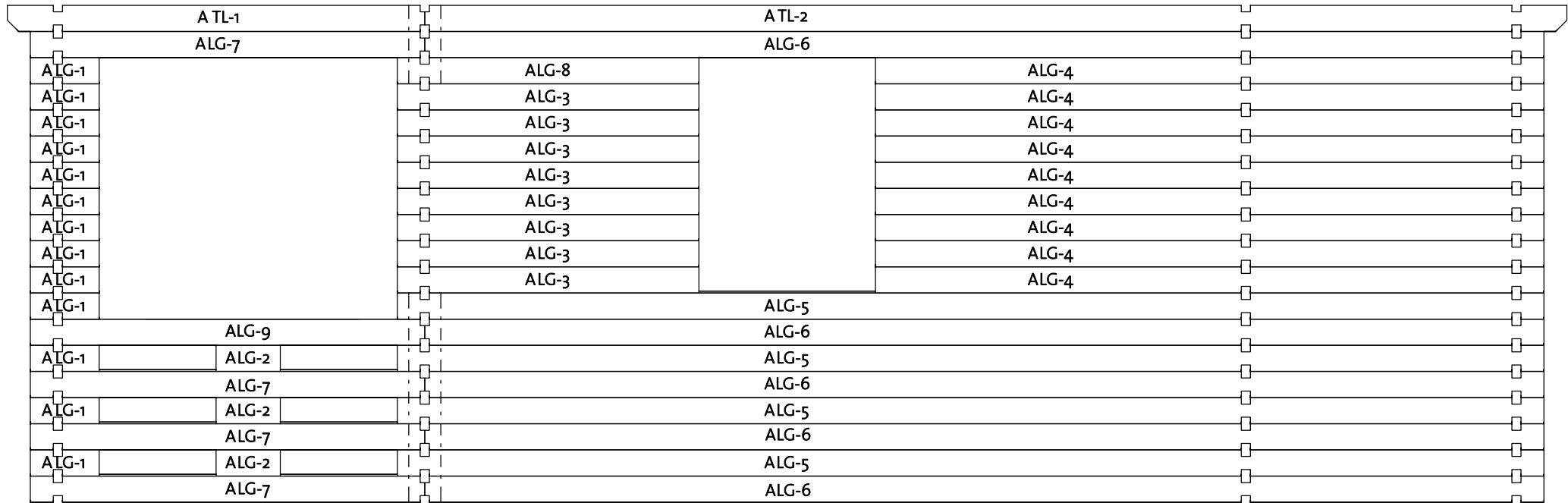

Johnny 40 (480x480)

Wall B

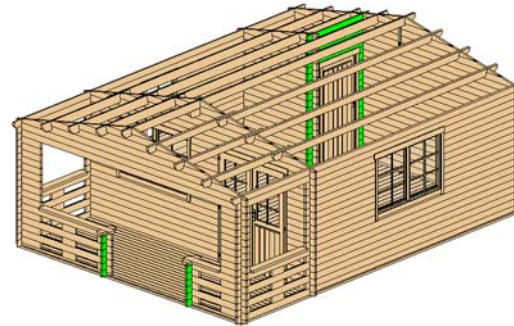

Wall B			
Mark	Profile	Count	Cut Length

BLG-1	40x114	34	285
BLG-2	40x114	3	1420
BLG-3	40x114	1	1420
BTL-1	40x94	1	1420

Wall AB			
Mark	Profile	Count	Cut Length

ABLG-1	40x114	6	240
ABTL-1	40x57	1	240

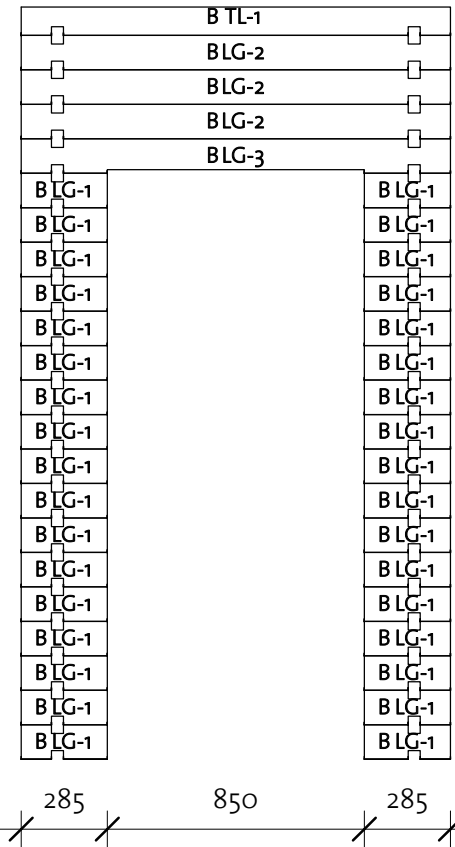
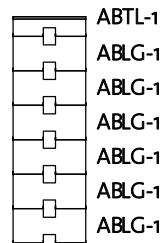

Log Profile Wall B	
Profile	Profile

40x114	
40x94	
40x57	

Wall BC			
Mark	Profile	Count	Cut Length

BCLG-1	40x114	6	240
BCTL-1	40x57	1	240

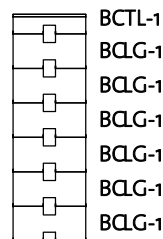

Johnny 40 (480x480)

Wall C

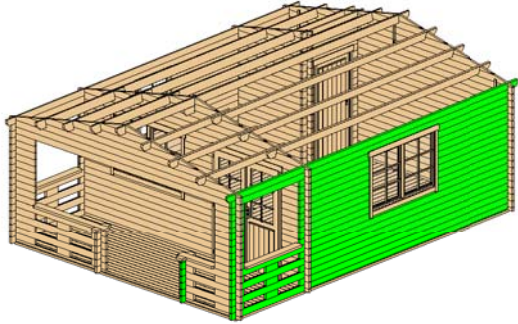

Log Profile Wall C

Profile	Profile
---------	---------

40X114



Log Profile Wall C

Profile	Profile
---------	---------

40X114



Wall C			
Mark	Profile	Count	Cut Length

CLG-1	40X114	3	280
CLG-2	40X114	13	300
CLG-3	40X114	9	1830
CLG-4	40X114	8	1630
CLG-5	40X114	4	5000
CLG-6	40X114	5	4880

Wall C			
Mark	Profile	Count	Cut Length

CLG-7	40X114	4	1720
CLG-8	40X114	1	1720
CLG-9	40X114	1	1630
CTL-1	40X114	1	1820
CTL-2	40X114	1	4980

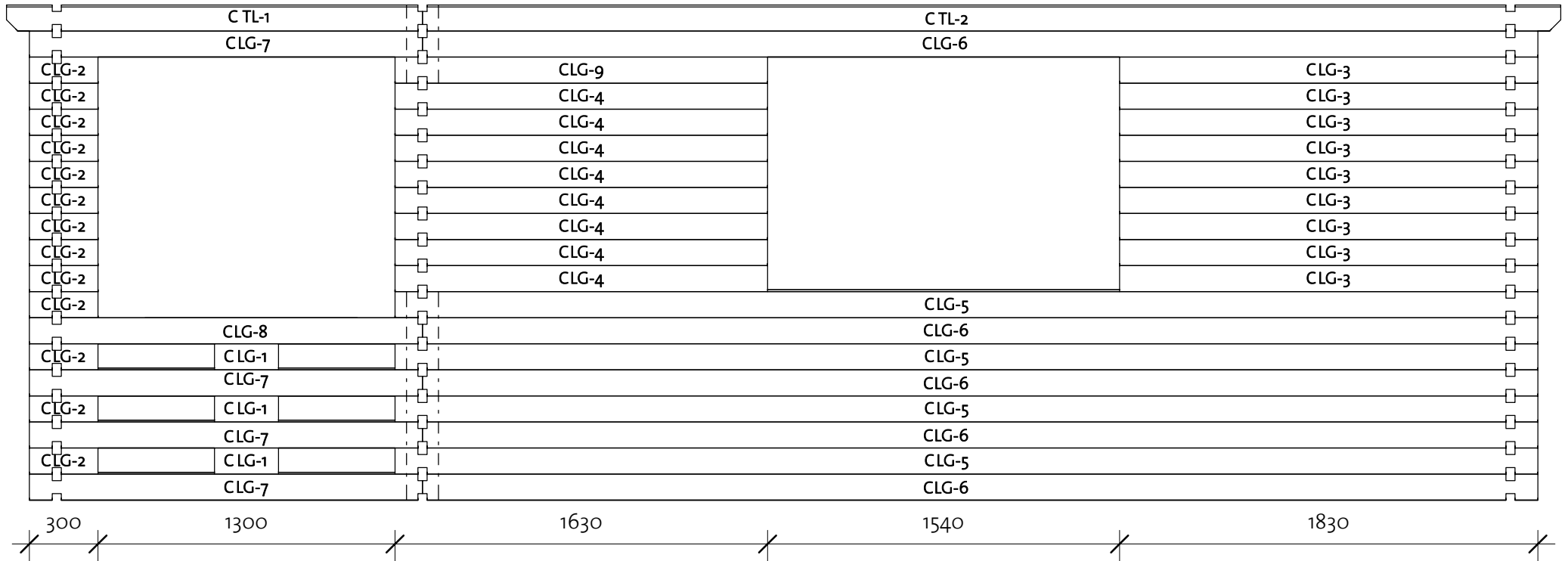

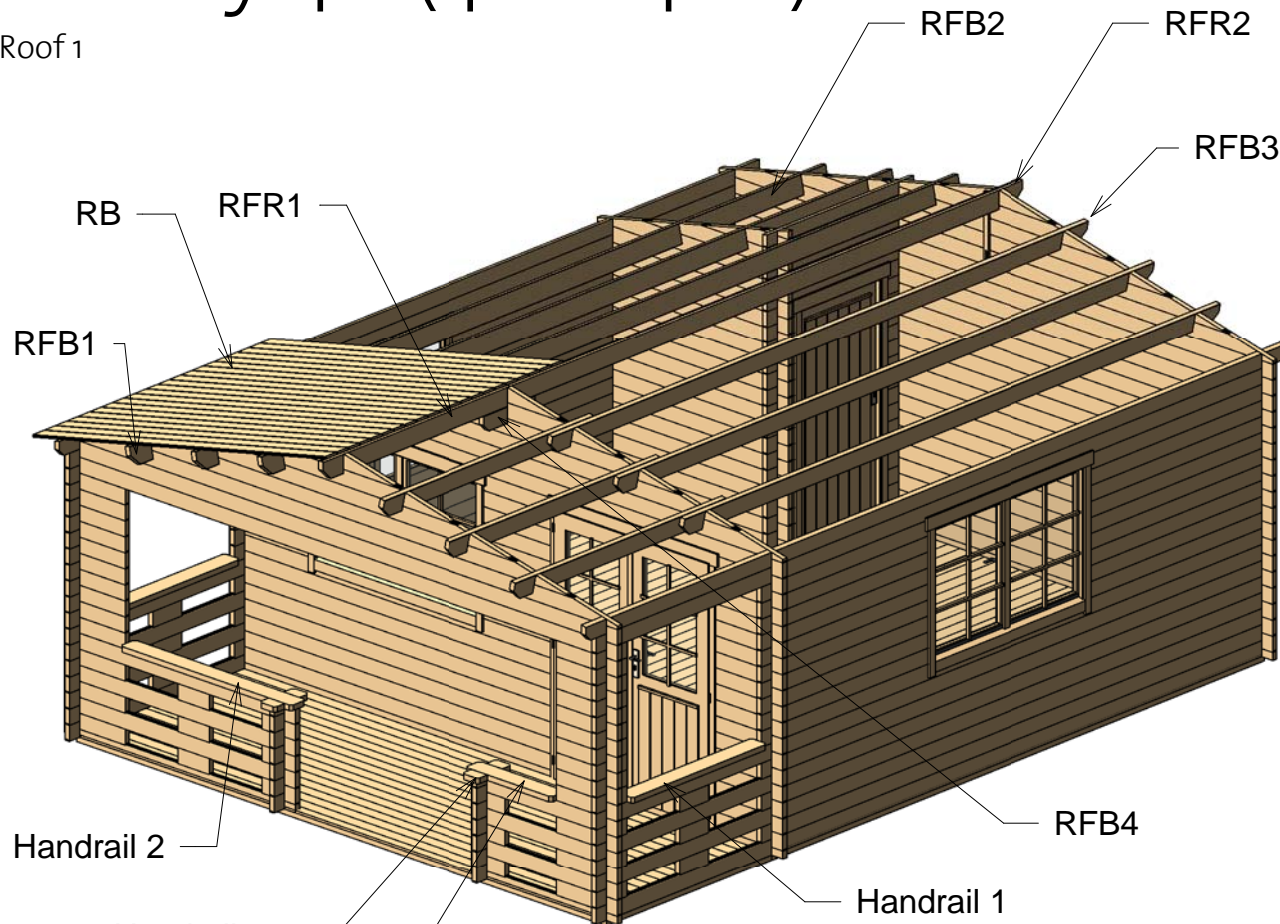

Johnny 40 (480x480)

Roof 1

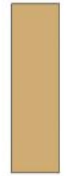

Type	Profile	Count	Length
Handrail 1	40X143	2	1300
Handrail 2	40X143	1	1545
Handrail 3	40X143	4	94
Handrail 4	40X143	1	775

Roof				
Mark	Type	Profile	Count	Cut Length

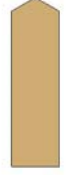
RB	18x110		126	2698
RFB1	Beam 40X143		6	2040
RFB2	Beam 40X143		2	5200
RFB3	Beam 40X143		4	5200
RFB4	Beam 40X120		1	500
RFR1	Ridge 40X143		1	1820
RFR2	Ridge 40X143		1	4980

Johnny 40 (480x480)

Roof 2

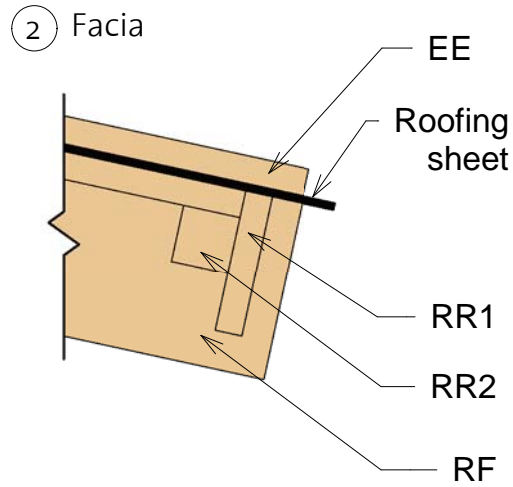
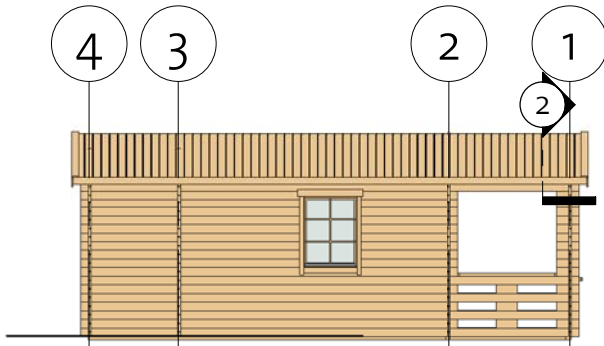

3 Roof Reinforcement

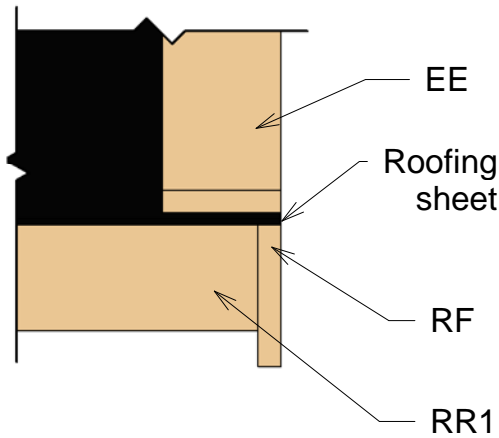
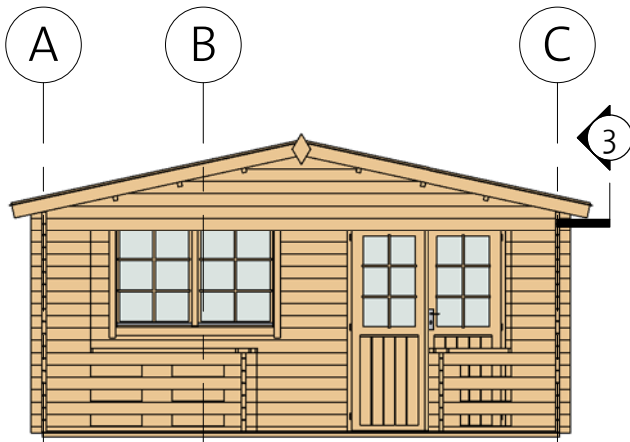

Fascia Schedule				
Mark	Type	Profile	Count	Length

EE	Eave Edging 18x95		4	2740
RF	Roof Fascia 18x120		4	2740
RR1	Roof reinforcement 18x95		4	3400
RR2	Roof reinforcement 38x38		4	3400

Johnny 40 (480x480)

Extras



Fasteners/Extras		
Name	Type	Count

Hitblock	300-400 mm	
Bolts	M8x70	20
Dowel	16,0 x 150	26
Screws	5,0 x 70	30
Nails	1,4 x 40	130
Screws	4,0 x 40	140
Screws	6,0 x 140	170
Screws	4,0 x 50	1500

91905163_190701

Door Schedule

Model	Type	Width	Height	Count
CD5R	Classic door 5, wood right	840	1890	1
CDD1R	Classic double door 1 right	1425	1955	1
DCB6	Door Crossbar 6	--	--	2
DB	Door beam 1440 mm	40	12	1
DB	Door beam 850 mm	40	12	1

Window Schedule

Model	Type	Width	Height	Count
CDW1	Classic double window 1	1530	990	2
CW1L	Classic window 1 left	765	990	1
CW12R	Classic window 12, full glass righth	540	540	1
WCB6	Windows Crossbar 6	--	--	5

Type	Count	Length
Windboard 18x40	7	2200

Type	Count
Romb	2

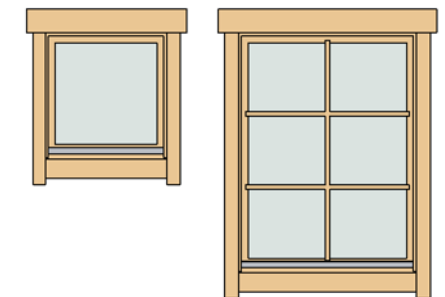
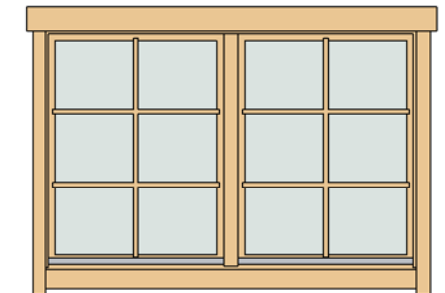



Johnny 40 (480x480)

List of all items 1

Impregnated foundation beams

Mark	Type	Profile	Count	Length
IFB1	IFB 70x40		9	4650
IFB2	IFB 70x40		9	1530
IFB3	IFB 70x40		2	4720
IFB4	IFB 70x40		2	493
IFB5	IFB 70x40		2	4790





Floor Schedule

Mark	Type	Profile	Count	Length
FB1	FB 18x110		14	1134
FB2	FB 18x110		15	3534
FB3	FB 18x110		31	4714
BB 1	BB 18x40		4	4800
BB 2	BB 18x40		2	3040

Terrace Schedule





Mark	Type	Profile	Count	Length
TB	TB 18x95		18	4714

Roof

Mark	Type	Profile	Count	Cut Length
RB	18x110		126	2698
RFB1	Beam 40x143		6	2040
RFB2	Beam 40x143		2	5200
RFB3	Beam 40x143		4	5200
RFB4	Beam 40x120		1	500
RFR1	Ridge 40x143		1	1820
RFR2	Ridge 40x143		1	4980

Johnny 40 (480x480)

List of all items 2

Fascia Schedule				
Mark	Type	Profile	Count	Length
EE	Eave Edging 18x95		4	2740
RF	Roof Fascia 18x120		4	2740
RR1	Roof reinforcement 18x95		4	3400
RR2	Roof reinforcement 38x38		4	3400

Johnny 40 (480x480)

List of all items 3

Wall 1			
Mark	Profile	Count	Cut Length

1BL-1	40X57	1	1315
1BL-2	40X57	1	2085
1LG-1	40X114	6	300
1LG-2	40X114	26	550
1LG-3	40X114	3	280
1LG-4 *	40X114	1	1050
1LG-5	40X114	2	1315
1LG-6	40X114	1	1315
1LG-7	40X114	2	2085
1LG-8	40X114	1	2085
1LG-9 *	40X114	1	2099
1LG-10*	40X114	1	3147
1LG-11 *	40X114	1	4196
1LG-12	40X114	2	5000
1LG-13*	40X114	1	5000

Wall 2			
Mark	Profile	Count	Cut Length

2BL-1	40X57	1	620
2BL-2	40X57	1	2940
2LG-1	40X114	17	620
2LG-2	40X114	9	655
2LG-3	40X114	9	745
2LG-4	40X114	1	1050
2LG-5	40X114	1	2099
2LG-6	40X114	8	2940
2LG-7	40X114	1	3147
2LG-8	40X114	1	4196
2LG-9	40X114	1	5000
2LG-10	40X114	1	5000

* Gable - delivered premounted

Wall 3			
Mark	Profile	Count	Cut Length

3BL-1	40X57	1	1720
3LG-1	40X114	1	794
3LG-2	40X114	1	1318
3LG-3	40X114	18	1720
3LG-4	40X114	1	1720
3LG-5	40X114	1	269

Wall 4			
Mark	Profile	Count	Cut Length

4BL-1	40X57	1	5000
4LG-1	40X114	5	588
4LG-2	40X114	1	1050
4LG-3	40X114	1	2099
4LG-4	40X114	1	3147
4LG-5	40X114	5	3868
4LG-6	40X114	1	4196
4LG-7	40X114	13	5000
4LG-8	40X114	1	5000

Johnny 40 (480x480)

List of all items 4

Wall A			
Mark	Profile	Count	Cut Length

ALG-1	40X114	13	300
ALG-2	40X114	3	280
ALG-3	40X114	8	1315
ALG-4	40X114	9	2915
ALG-5	40X114	4	5000
ALG-6	40X114	5	4880

Wall B			
Mark	Profile	Count	Cut Length

BLG-1	40X114	34	285
BLG-2	40X114	3	1420
BLG-3	40X114	1	1420
BTL-1	40X94	1	1420

Wall C			
Mark	Profile	Count	Cut Length

CLG-1	40X114	3	280
CLG-2	40X114	13	300
CLG-3	40X114	9	1830
CLG-4	40X114	8	1630
CLG-5	40X114	4	5000
CLG-6	40X114	5	4880

Wall BC			
Mark	Profile	Count	Cut Length

BCLG-1	40X114	6	240
BCTL-1	40X57	1	240

Wall A			
Mark	Profile	Count	Cut Length

ALG-7	40X114	4	1720
ALG-8	40X114	1	1315
ALG-9	40X114	1	1720
ATL-1	40X114	1	1820
ATL-2	40X114	1	4980

Wall C			
Mark	Profile	Count	Cut Length

CLG-7	40X114	4	1720
CLG-8	40X114	1	1720
CLG-9	40X114	1	1630
CTL-1	40X114	1	1820
CTL-2	40X114	1	4980

Wall AB			
Mark	Profile	Count	Cut Length

ABLG-1	40X114	6	240
ABTL-1	40X57	1	240

Log profiles	
Profile	images2

40X57	
-------	---

40X57	
-------	---

40X94	
-------	--

40X114	
--------	---

40X114	
--------	---

40X114	
--------	---