

Nora I 40 (300x550)

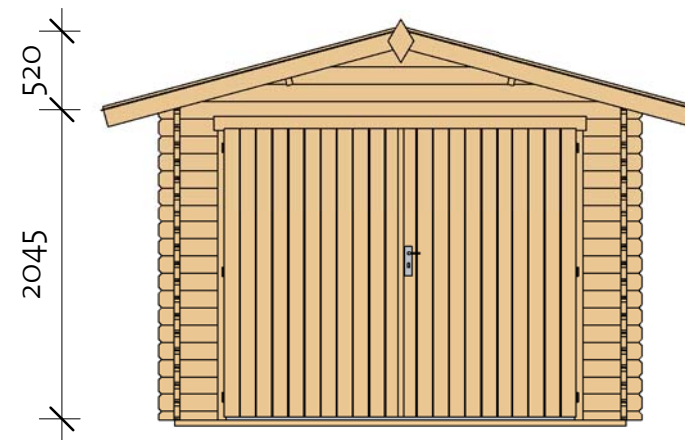

Nora I 40 (300x550)

Foundation

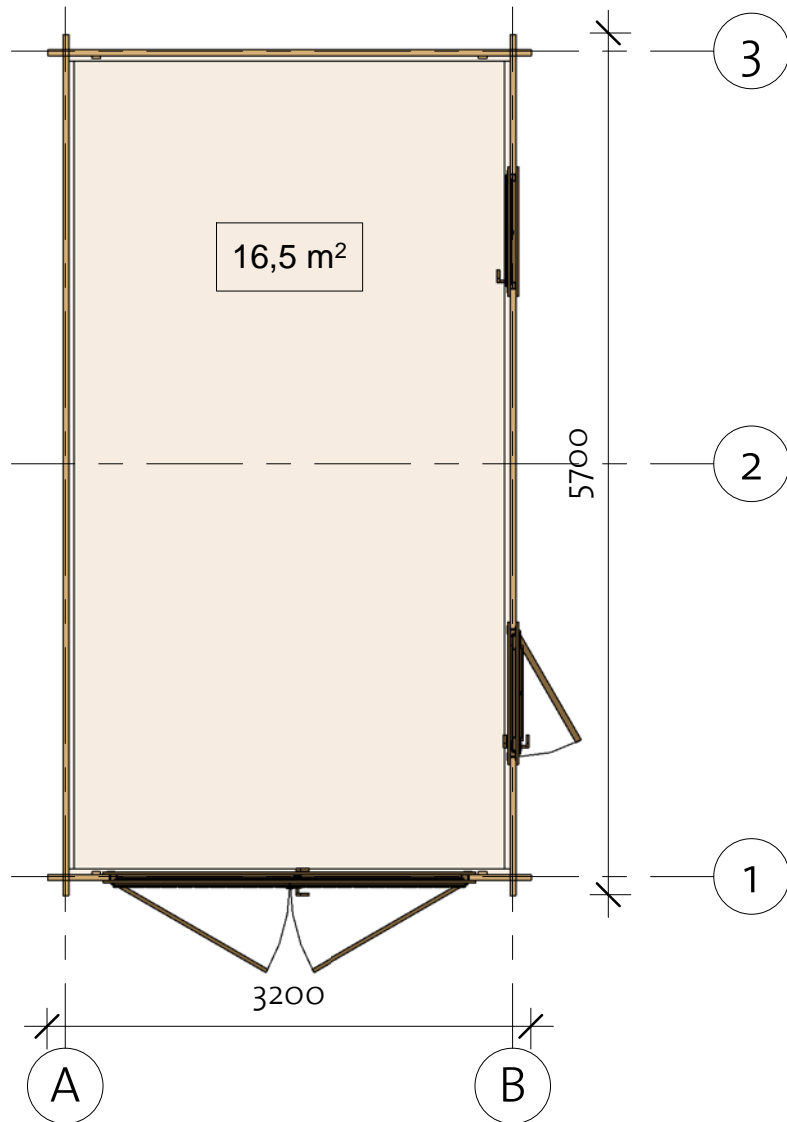
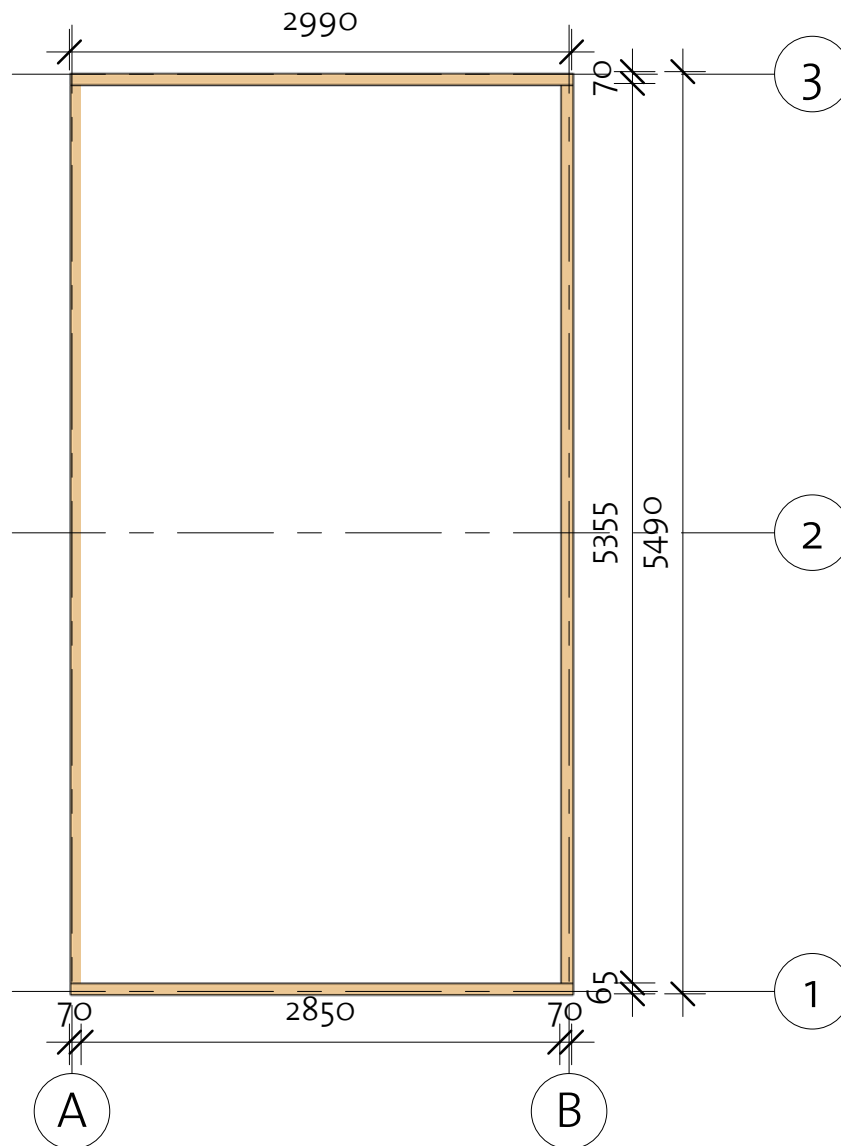

Impregnated foundation beams				
Mark	Type	Profile	Count	Length
IFB1	IFB 70x40		2	2990
IFB2	IFB 70x40		2	5350

Nora I 40 (300x550)

Floor Plan

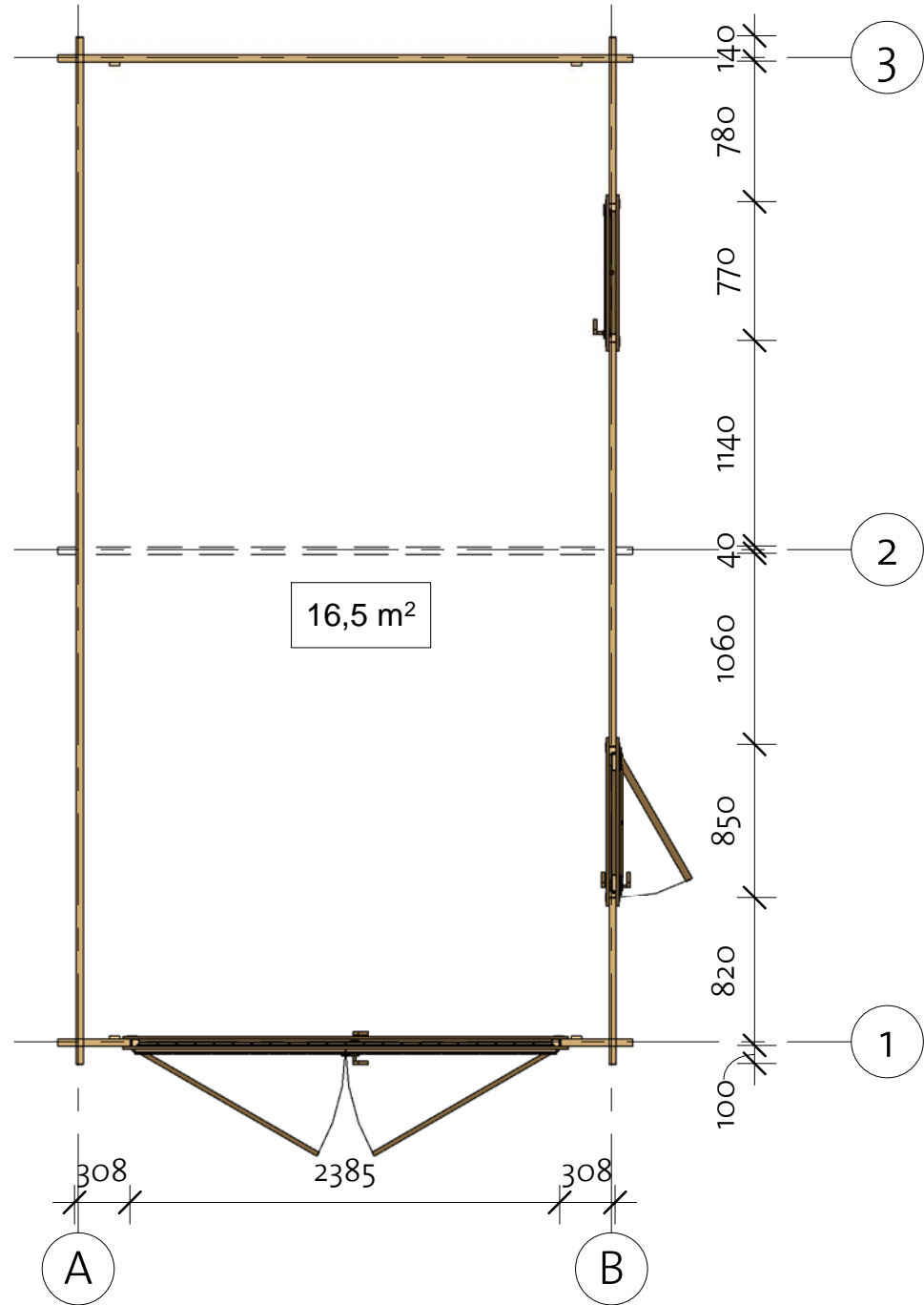

Nora I 40 (300x550)

Wall 1

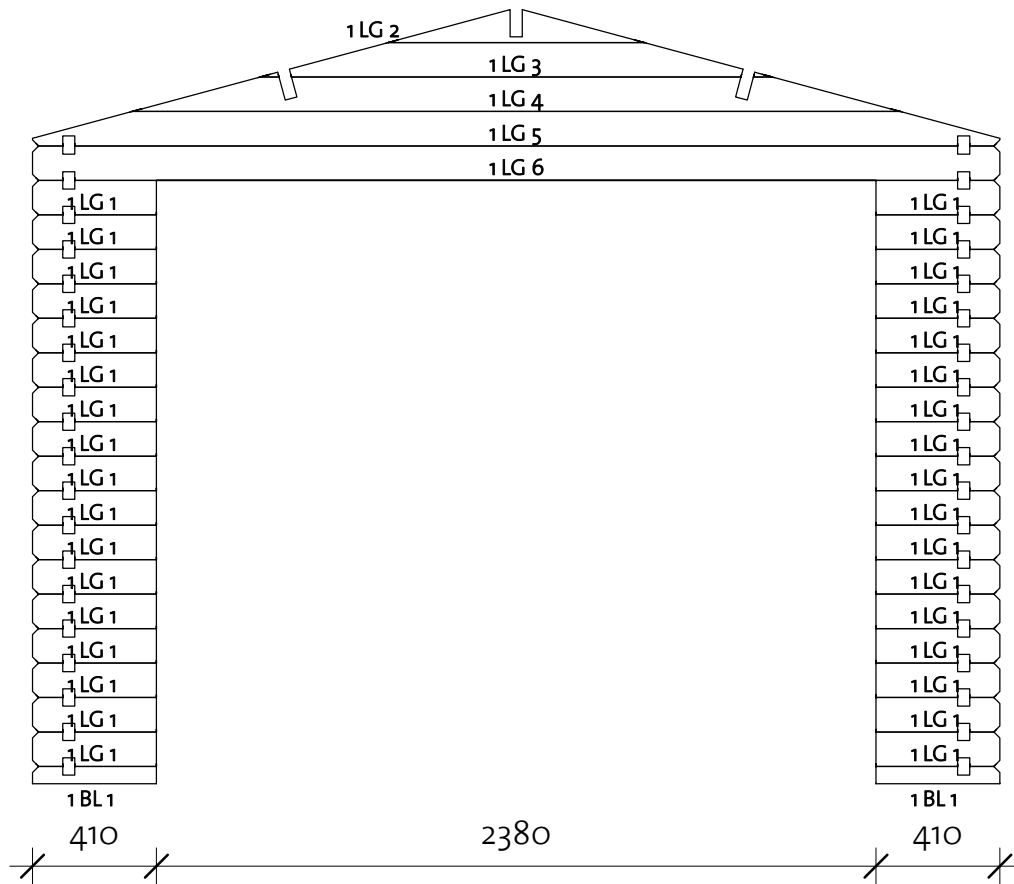
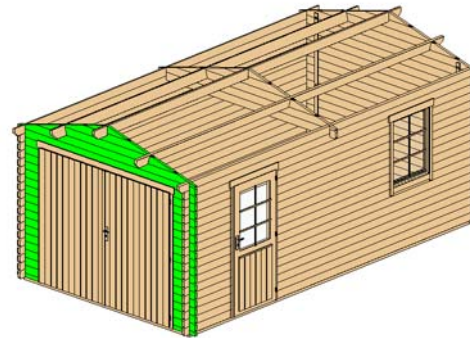

Wall 1			
Mark	Profile	Count	Cut Length

1BL 1	40X57	2	410
1LG 1	40X114	34	410
1LG 2 *	40X114	1	848
1LG 3 *	40X114	1	1694
1LG 4 *	40X114	1	2541
1LG 5 *	40X114	1	3200
1LG 6	40X114	1	3200

* Gable - delivered premounted

Log Profile Wall 1	
Profile	Profile

40X57	
40X114	

Nora I 40 (300x550)

Wall 2

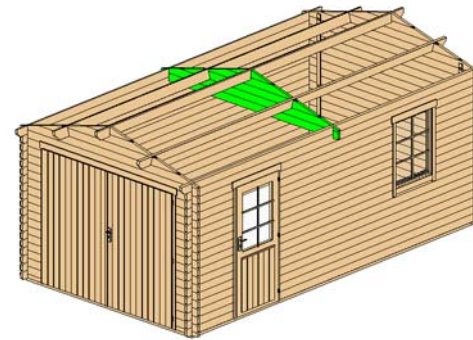

Wall 2			
Mark	Profile	Count	Cut Length

2LG 1*	40x114	1	848
2LG 2*	40x114	1	1694
2LG 3*	40x114	1	2541
2LG 4*	40x114	1	3200
2LG 5	40x114	1	3200

* Gable - delivered premounted

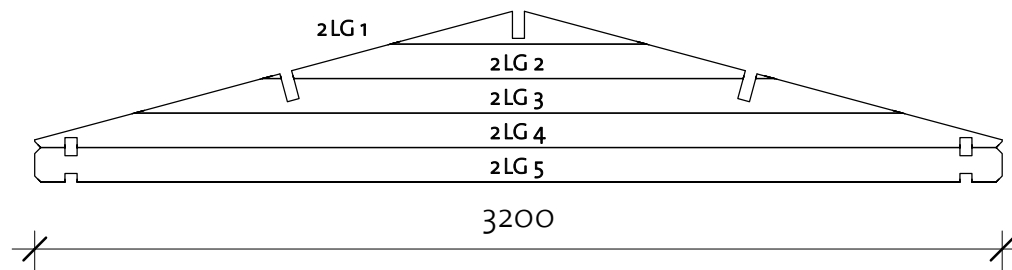

Log Profile Wall 2	
Profile	Profile

40x114	
--------	--

Nora I 40 (300x550)

Wall 3

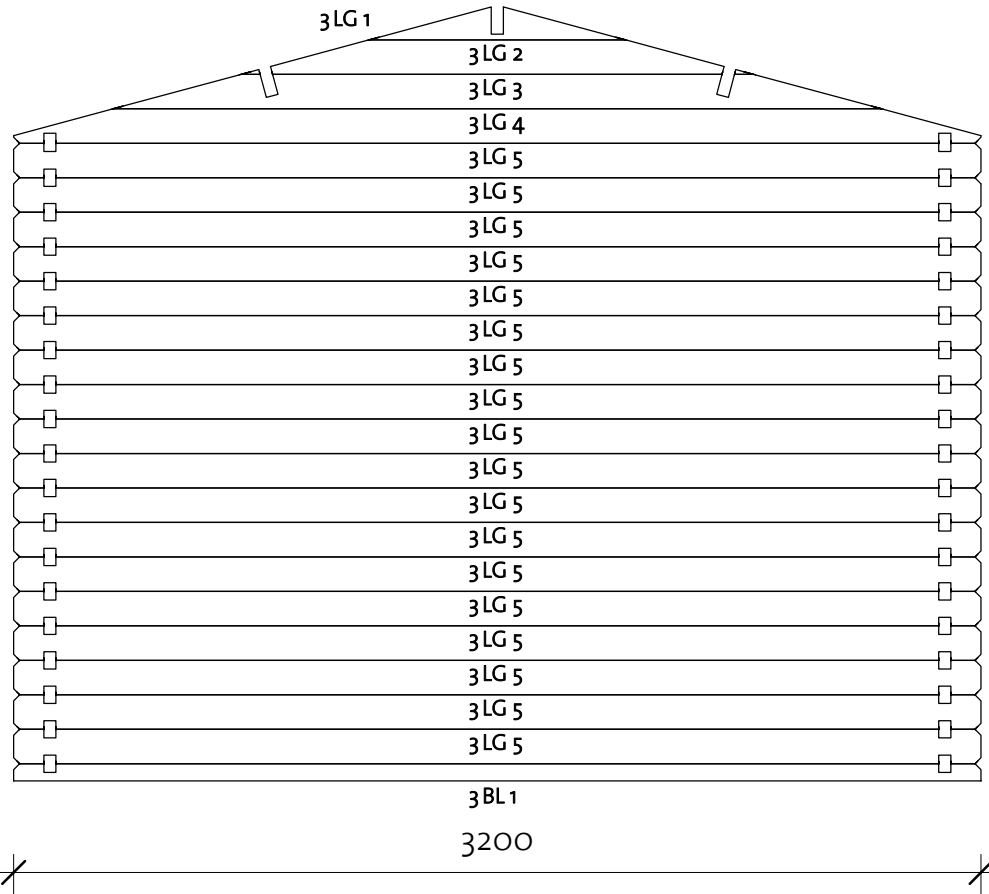
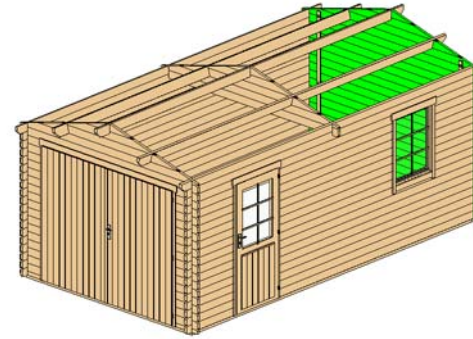



Wall 3			
Mark	Profile	Count	Cut Length

3BL 1	40x57	1	3200
3LG 1*	40x114	1	848
3LG 2*	40x114	1	1694
3LG 3*	40x114	1	2541
3LG 4*	40x114	1	3200
3LG 5	40x114	18	3200

* Gable - delivered premounted

Log Profile Wall 3	
Profile	Profile

40x57	
40x114	

Nora I 40 (300x550)

Wall A

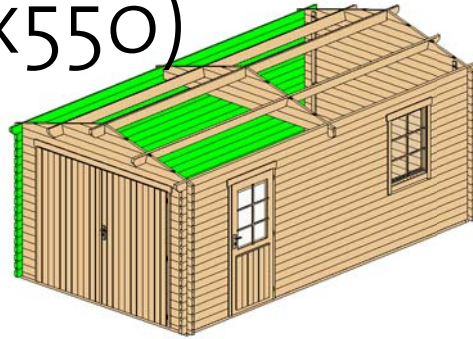

Wall A			
Mark	Profile	Count	Cut Length

ALG2	40x114	1	5700
ALG1	40x114	17	5700
ATL1	40x120	1	5900

Log Profile Wall A	
Profile	Profile

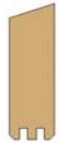
40x114	
40x120	

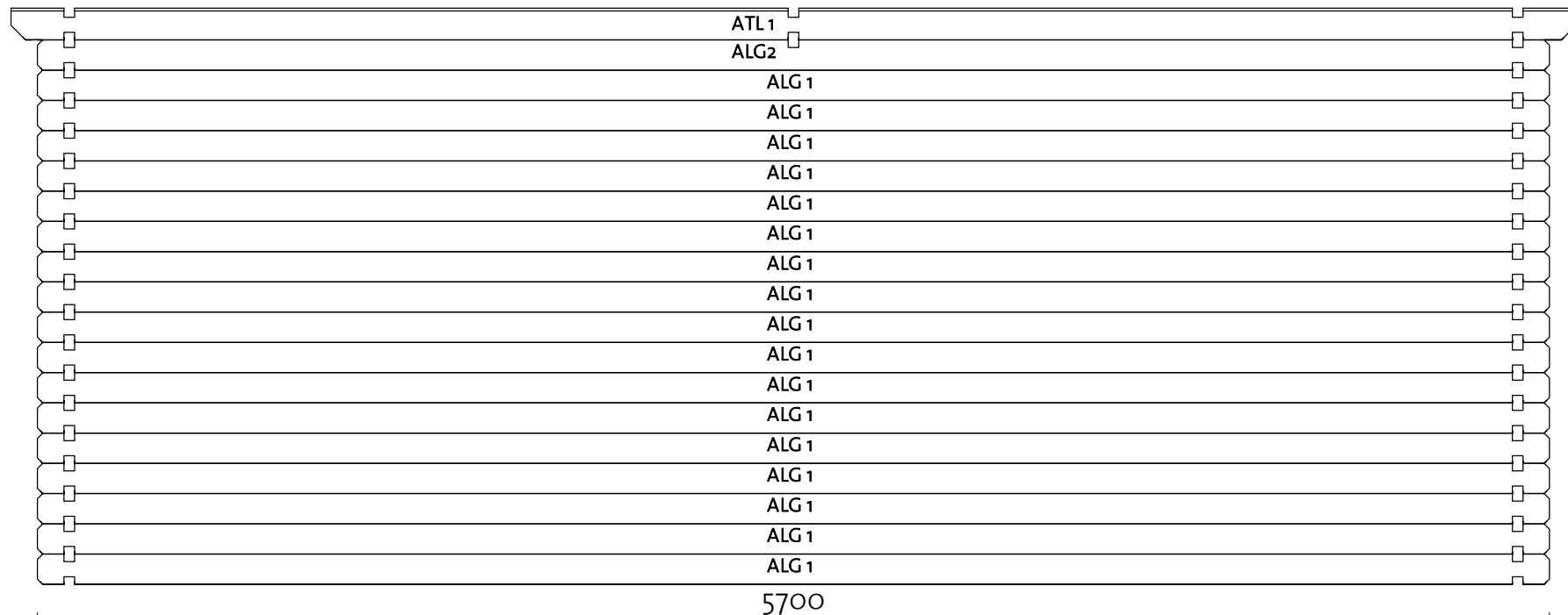

Nora I 40 (300x550)

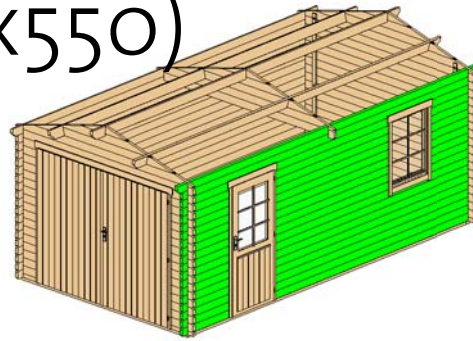

Wall B



Wall B			
Mark	Profile	Count	Cut Length

BLG 1	40X114	26	920
BLG 2	40X114	9	2240
BLG 3	40X114	8	3930
BLG 4	40X114	1	5700
BTL 1	40X120	1	5900

Log Profile Wall B	
Profile	Profile

40X114	
40X120	

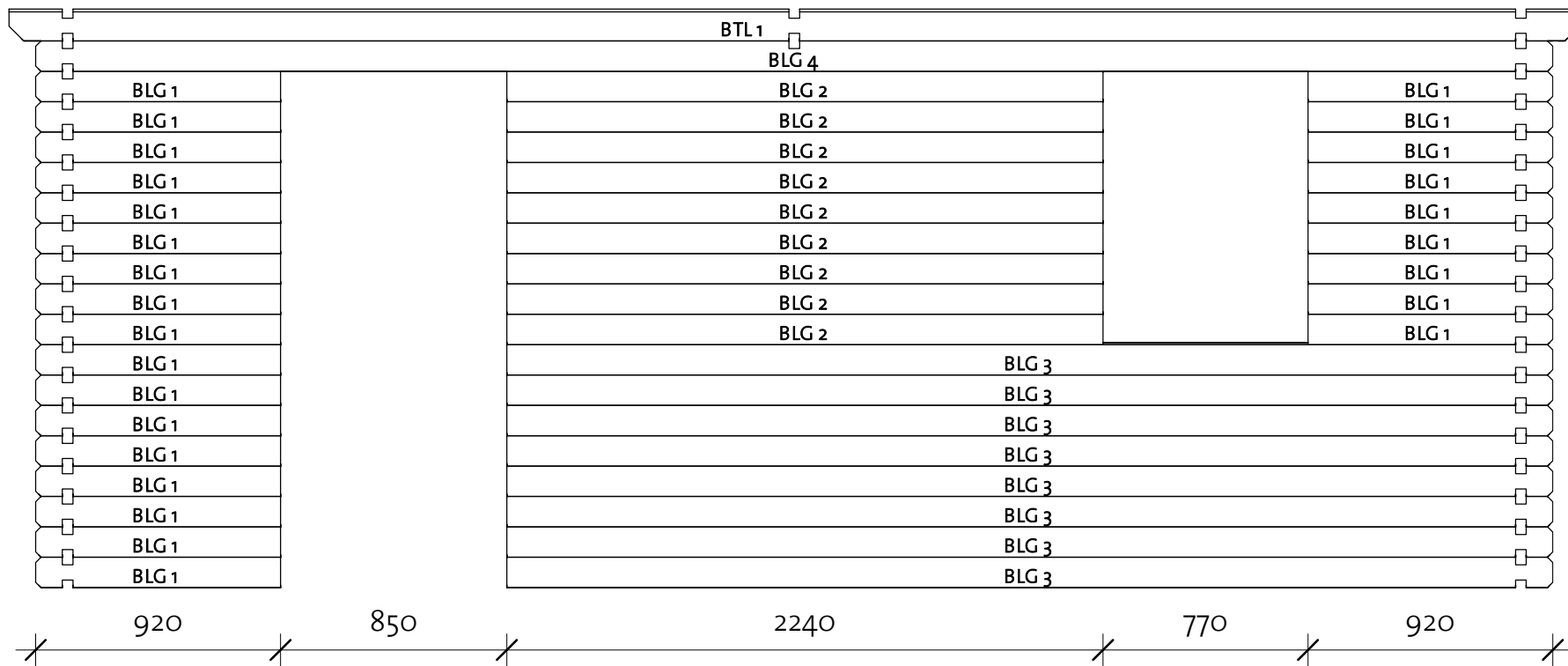



4400001_190509

Nora I 40 (300x550)

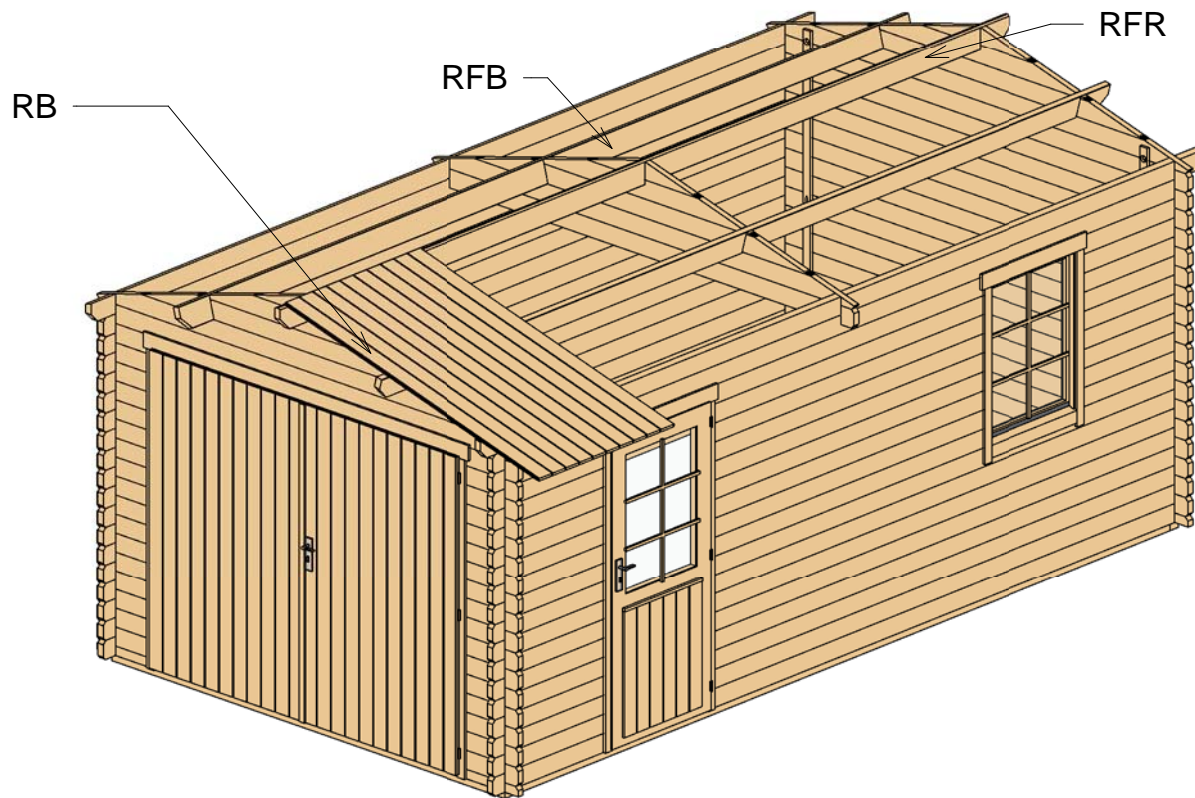
Roof 1



Roof				
Mark	Type	Profile	Count	Length
RFR	Ridge 40x143		1	5950
RFB	Beam 40x143		2	5950
RB	Roofboard 18x110		112	2000

Nora I 40 (300x550)

Roof 2

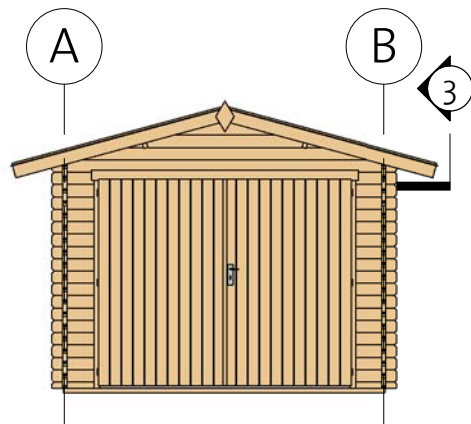
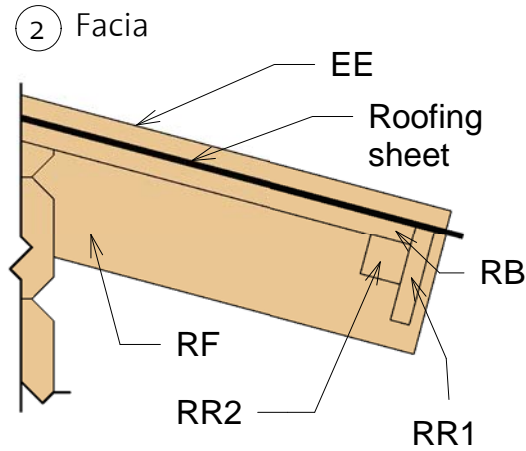
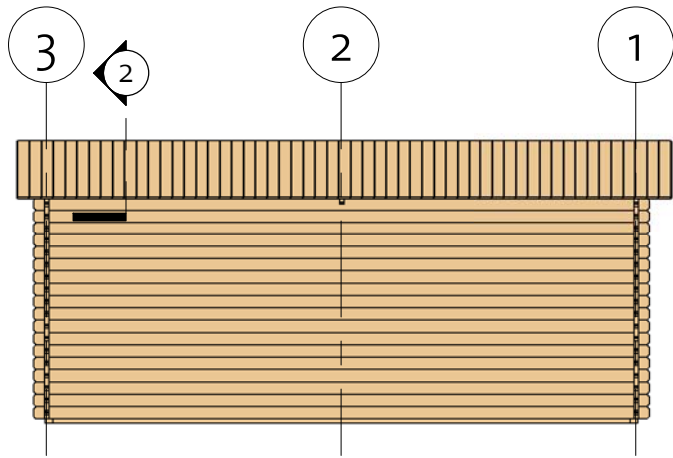

③ Roof Reinforcement

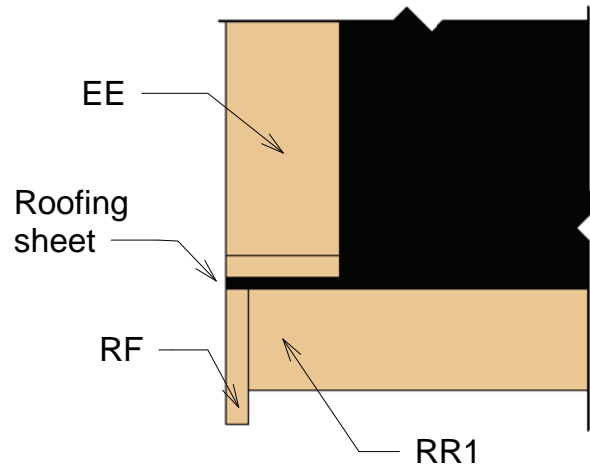

Fascia Schedule				
Mark	Type	Profile	Count	Length
EE	Eave Edging 18x90		4	2034
RF	Roof Fascia 18x110		1	2034
RF	Roof Fascia 18x115		3	2034
RR1	Roof reinforcement 18x90		2	5950
RR2	Roof reinforcement 38x38		2	5950

Nora I 40 (300x550)

Extras

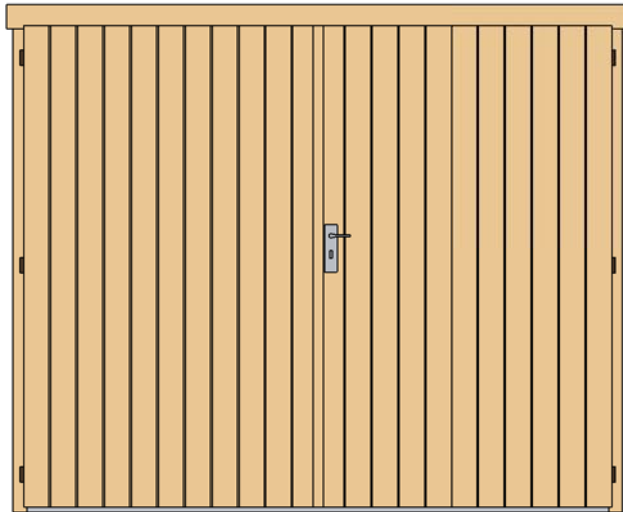

Door Schedule				
Model	Type	Width	Height	Count
CDD10R	Classic double door 10, wood right	2370	1955	1
CD1	Classic door 1	840	1890	1
DCB6	Door crossbar 6	--	--	1

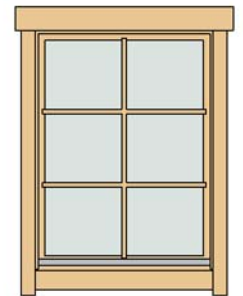

Fasteners/Extras		
Name	Type	Count

Hitblock	300-400 mm	
Bolts	M8 x 70	10
Screws	5,0 x 70	10
Screws	6,0 x 140	40
Screws	4,0 x 40	100
Screws	4,0 x 50	350

4400001_190509



Type	Count	Lenght
Windboard 18x38	4	2200

Family	Count
--------	-------

Romb	2
------	---



Window Schedule				
Model	Type	Width	Height	Count



CW1L	Classic window 1 left	765	990	1
------	-----------------------	-----	-----	---

WCB6	Window crossbar 6	--	--	1
------	-------------------	----	----	---



Nora I 40 (300x550)

List of all items 1





Impregnated foundation beams				
Mark	Type	Profile	Count	Length

IFB1	IFB 70x40		2	2990
IFB2	IFB 70x40		2	5350

Roof				
Mark	Type	Profile	Count	Length

RFR	Ridge 40x143		1	5950
RFB	Beam 40x143		2	5950
RB	Roofboard 18x110		112	2000

Fascia Schedule				
Mark	Type	Profile	Count	Length

EE	Eave Edging 18x90		4	2034
RF	Roof Fascia 18x110		1	2034
RF	Roof Fascia 18x115		3	2034
RR1	Roof reinforcement 18x90		2	5950
RR2	Roof reinforcement 38x38		2	5950

Nora I 40 (300x550)

List of all items 2

Wall 1			
Mark	Profile	Count	Cut Length



1BL 1	40x57	2	410
1LG 1	40x114	34	410
1LG 2 *	40x114	1	848
1LG 3 *	40x114	1	1694
1LG 4 *	40x114	1	2541
1LG 5 *	40x114	1	3200
1LG 6	40x114	1	3200

Wall 3			
Mark	Profile	Count	Cut Length

3BL 1	40x57	1	3200
3LG 1 *	40x114	1	848
3LG 2 *	40x114	1	1694
3LG 3 *	40x114	1	2541
3LG 4 *	40x114	1	3200
3LG 5	40x114	18	3200

*Gable-delivered premounted

Log Profiles	
Profile	Profile

40x57	
40x114	

Wall 2			
Mark	Profile	Count	Cut Length

2LG 1 *	40x114	1	848
2LG 2 *	40x114	1	1694
2LG 3 *	40x114	1	2541
2LG 4 *	40x114	1	3200
2LG 5	40x114	1	3200

Wall A			
Mark	Profile	Count	Cut Length

ALG2	40x114	1	5700
ALG 1	40x114	17	5700
ATL 1	40x120	1	5900

Wall B			
Mark	Profile	Count	Cut Length

BLG 1	40x114	26	920
BLG 2	40x114	9	2240
BLG 3	40x114	8	3930
BLG 4	40x114	1	5700
BTL 1	40x120	1	5900

Log Profiles	
Profile	Profile

40x120	
--------	---