

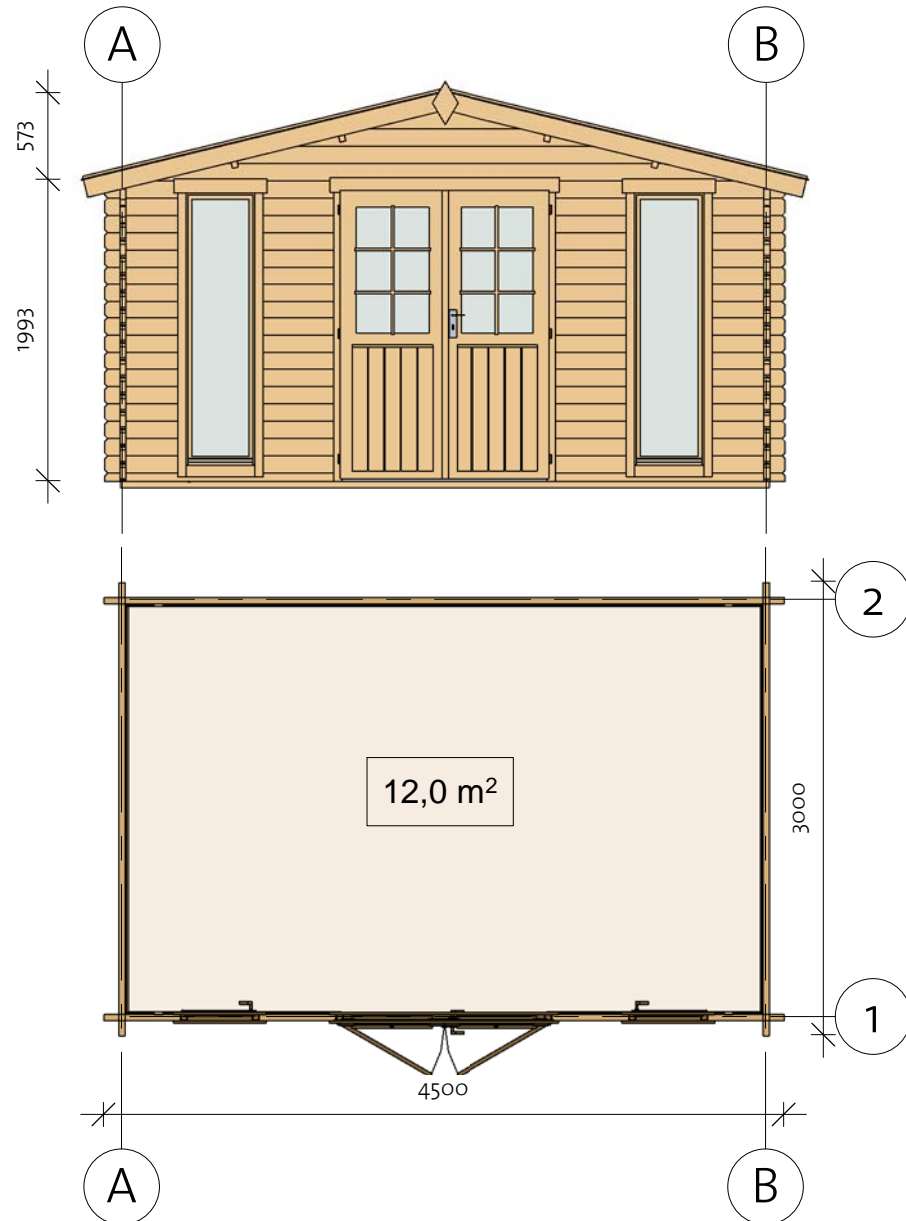

Placas I 40 (430x280)

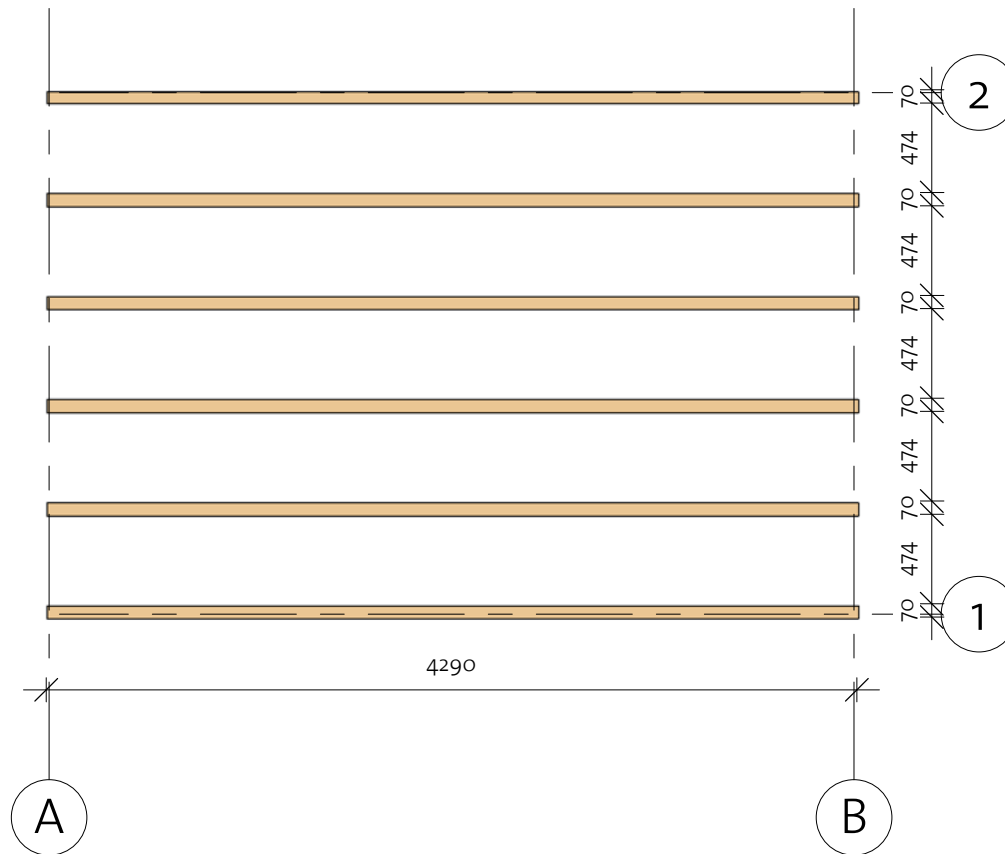

Placas I 40 (430x280)

Foundation



Impregnated foundation beams				
Mark	Type	Profile	Count	Length
IFB	IFB 70x40		6	4290

Placas I 40 (430x280)

Floor Plan

1 Baseboard

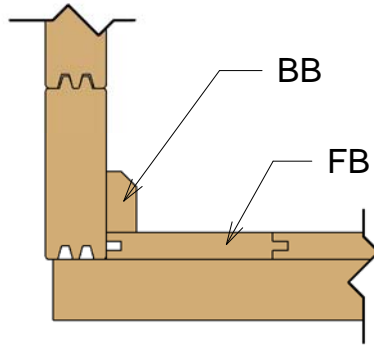

Floor Schedule				
Mark	Type	Profile	Count	Length
FB	FB 18x110		40	2717
BB	BB 20x40		2	4300
BB	BB 20x40		2	2800

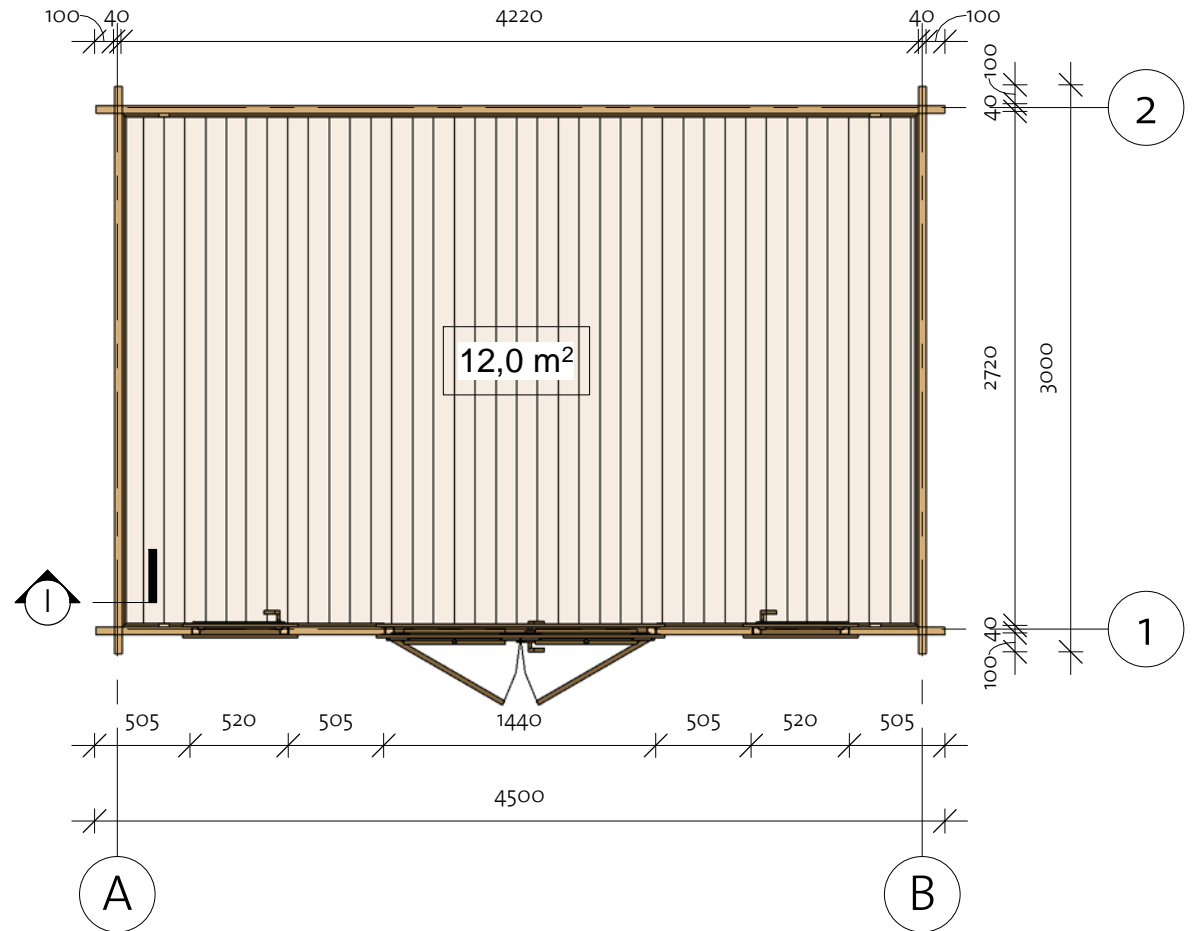

Placas I 40 (430x280)

Wall 1

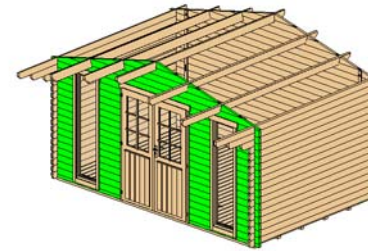



Wall 1			
Mark	Profile	Count	Cut Length

1BL-1	40x57	2	1530
1LG-1 *	40x114	1	941
1LG-2 *	40x114	1	1878
1LG-3 *	40x114	1	2801
1LG-4 *	40x114	1	3752
1LG-5	40x114	34	505
1LG-6 *	40x114	1	4500
1LG-7	40x114	34	505

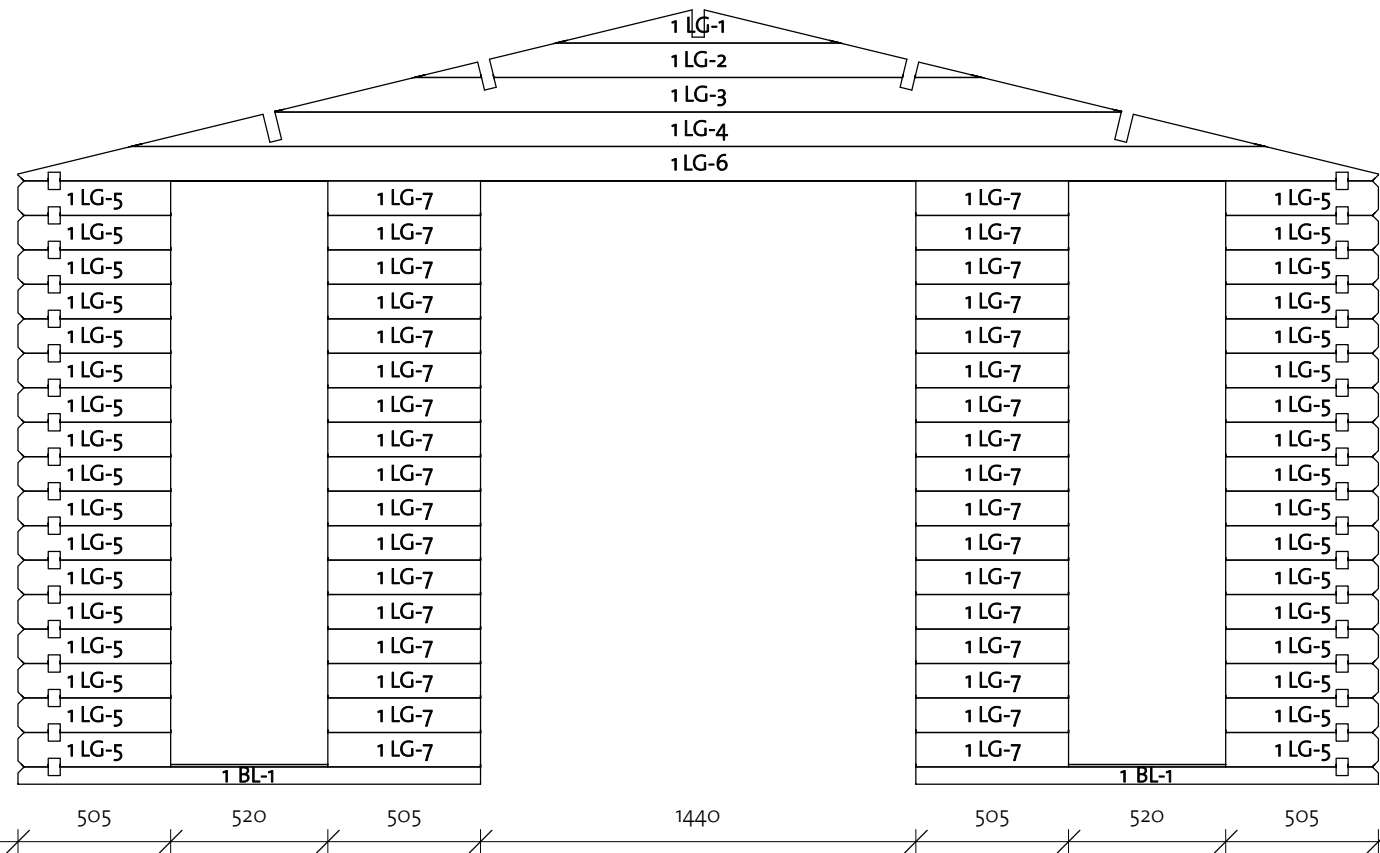
*Gable-delivered premounted



Log Profile Wall 1	
Profile	Profile

40x57	
40x114	

Placas I 40 (430x280)

Wall A

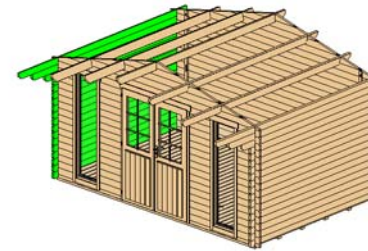

Wall A			
Mark	Profile	Count	Cut Length

ALG-1	40x114	15	3000
ALG-2	28x114	1	3200
ALG-3	28x114	1	3500
ATL-1	40x114	1	3900

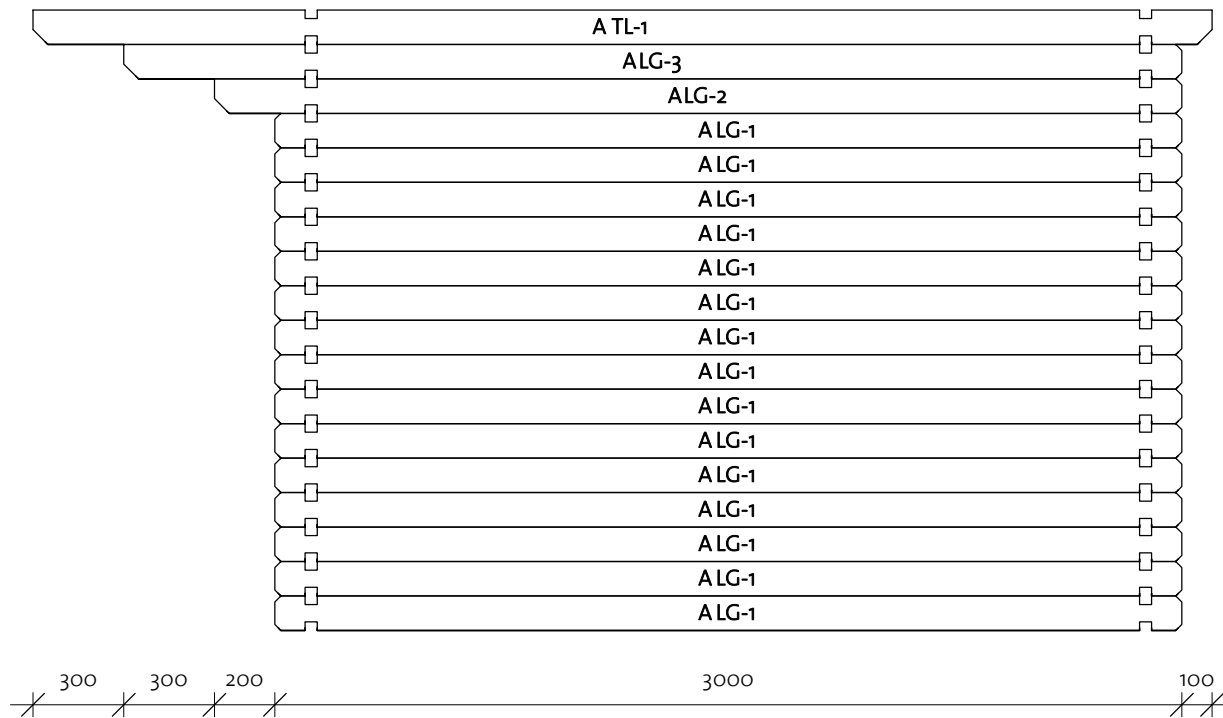

Log Profile Wall A	
Profile	Profile

40x114	
40x114	

Placas I 40 (430x280)

Wall B

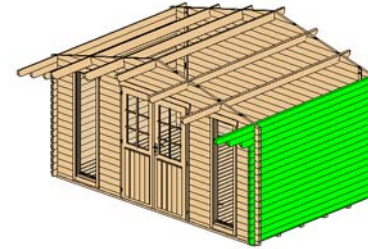

Wall B			
Mark	Profile	Count	Cut Length

BLG-1	40x114	15	3000
BLG-2	28x114	1	3200
BLG-3	28x114	1	3500
BTL-1	40x114	1	3900

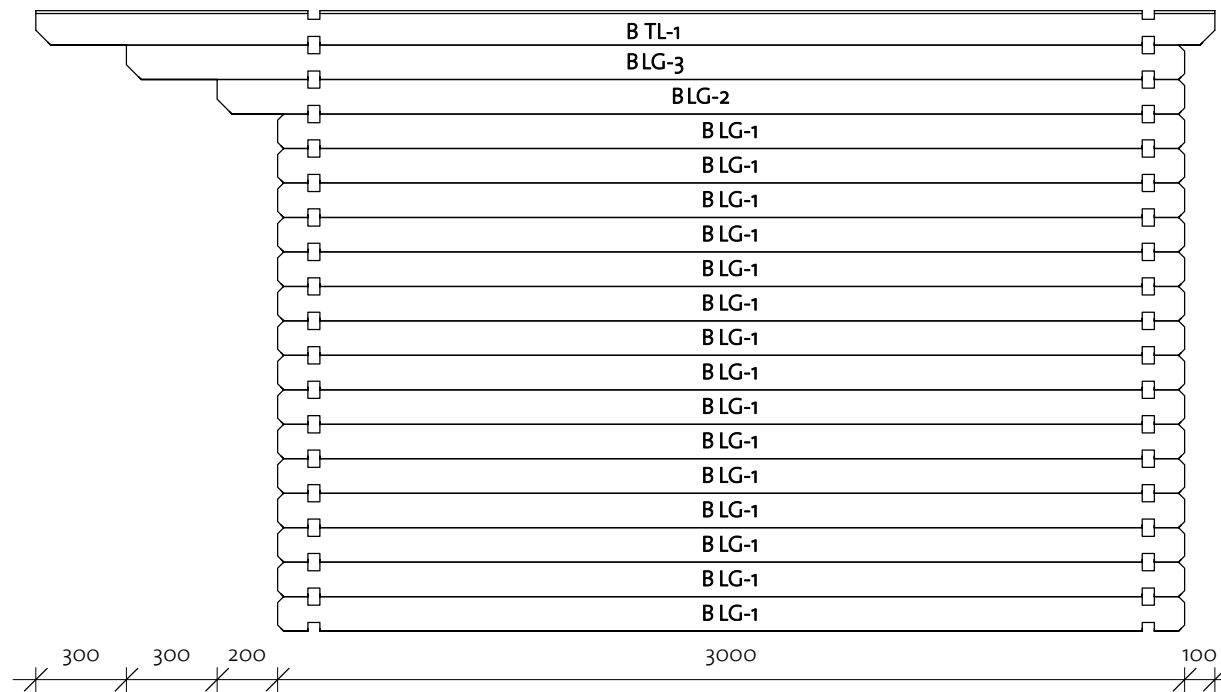





Log Profile Wall B	
Profile	Profile

40X114	
40X114	

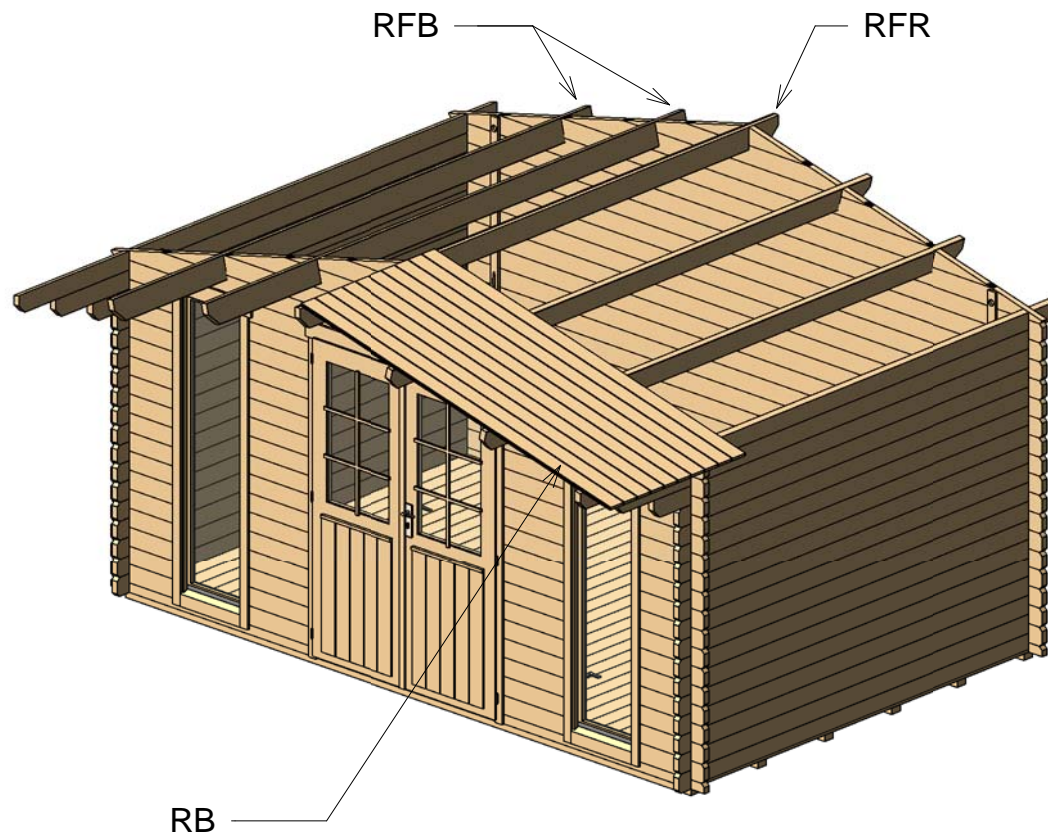
Placas I 40 (430x280)

Roof 1



Roof				
Mark	Type	Profile	Count	Length
RFR	Ridge 40x143		1	3900
RFB	Beam 40x143		4	3900
RB	18x110		74	2420

Placas I 40 (430x280)

Roof 2

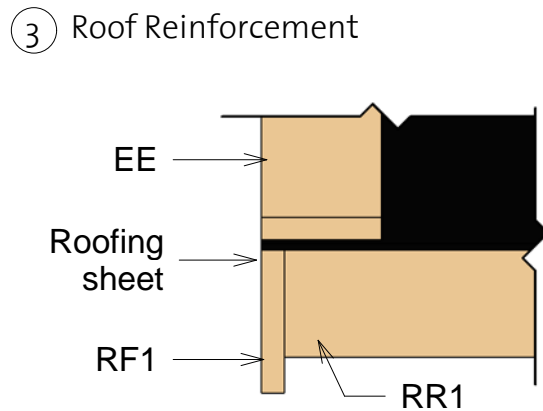
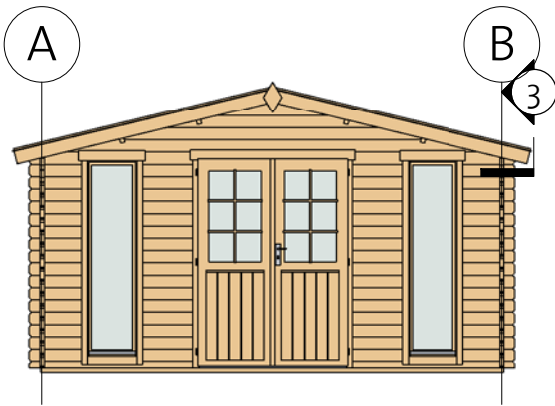
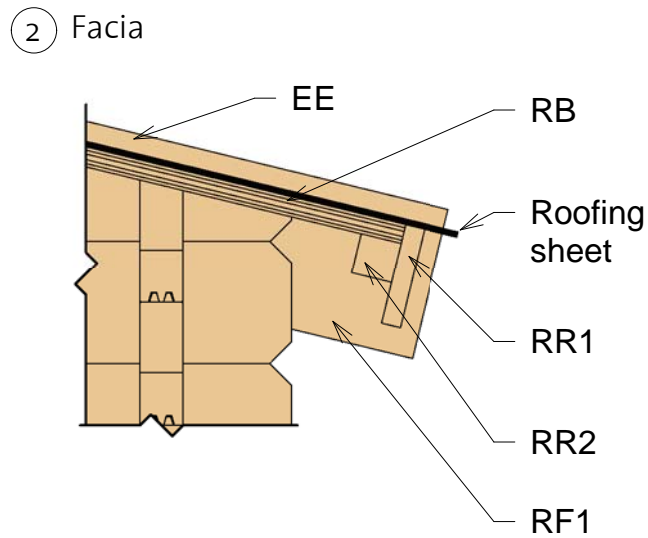
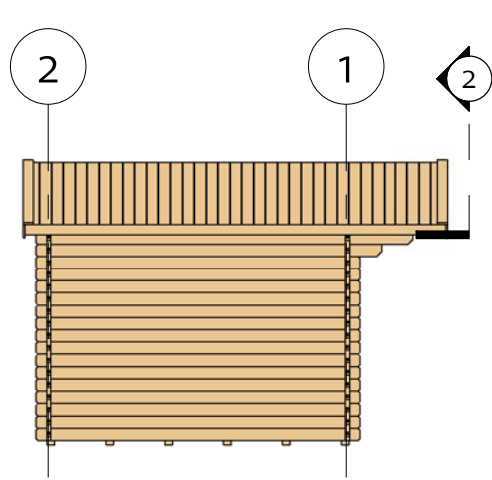

Fascia Schedule				
Mark	Type	Profile	Count	Length
EE	Eave Edging 18x95		4	2460
RF1	Roof Fascia 18x120		4	2460
RR1	Roof reinforcement 18x95		2	3900
RR2	Roof reinforcement 38x38		2	3900

Placas I 40 (430x280)

Extras



Door Schedule				
Mark	Type	Width	Height	Count
CDD1R	Classic double door 1 right	1425	1955	1
DCB6	Door Crossbar 6	--	--	2

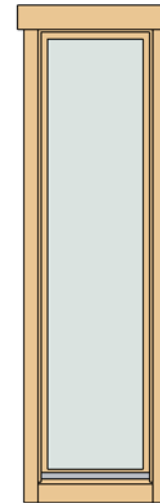

Window Schedule				
Mark	Type	Width	Height	Count
CW3L	Classic window 3, full glass left	515	1890	1
CW3R	Classic window 3, full glass right	515	1890	1

Monitor - Fasteners/Extras		
Name	Type	Count

Hitblock	300-400 mm	
Screws	5,0 x 70	10
Bolts	M8 x 70	12
Screws	6,0x140	35
Nails	1,4 x 40	40
Screws	4,0 x 40	90
Screws	4,0 x 50	550

Family	Count
--------	-------

Romb	2
------	---



Type	Count	Length
------	-------	--------

Windboard 18x40	4	2000
--------------------	---	------

190828



Placas I 40 (430x280)

List of all items 1



Impregnated foundation beams

Mark	Type	Profile	Count	Length
IFB	IFB 70x40		6	4290





Floor Schedule

Mark	Type	Profile	Count	Length
FB	FB 18x110		40	2717
BB	BB 20x40		2	4300
BB	BB 20x40		2	2800

Roof

Mark	Type	Profile	Count	Length
RFR	Ridge 40x143		1	3900
RFB	Beam 40x143		4	3900
RB	18x110		74	2420

Fascia Schedule

Mark	Type	Profile	Count	Length
EE	Eave Edging 18x95		4	2460
RF1	Roof Fascia 18x120		4	2460
RR1	Roof reinforcement 18x95		2	3900
RR2	Roof reinforcement 38x38		2	3900

Placas I 40 (430x280)

List of all items 2

Wall 1			
Mark	Profile	Count	Cut Length

1BL-1	40x57	2	1530
1LG-1 *	40x114	1	941
1LG-2 *	40x114	1	1878
1LG-3 *	40x114	1	2801
1LG-4 *	40x114	1	3752
1LG-5	40x114	34	505
1LG-6 *	40x114	1	4500
1LG-7	40x114	34	505

Wall 2			
Mark	Profile	Count	Cut Length

2BL-1	40x57	1	4500
2LG-1 *	40x114	1	941
2LG-2 *	40x114	1	1878
2LG-3 *	40x114	1	2801
2LG-4 *	40x114	1	3752
2LG-5 *	40x114	1	4500
2LG-6	40x114	17	4500

*Gable-delivered premounted

Wall A			
Mark	Profile	Count	Cut Length



ALG-1	40x114	15	3000
ALG-2	28x114	1	3200
ALG-3	28x114	1	3500
ATL-1	40x114	1	3900

Wall B			
Mark	Profile	Count	Cut Length

BLG-1	40x114	15	3000
BLG-2	28x114	1	3200
BLG-3	28x114	1	3500
BTL-1	40x114	1	3900

* Gable - delivered premounted

Log Profiles	
Profile	Profile

40x57	
40x114	

Log Profiles	
Profile	Profile

40x114	
--------	---