

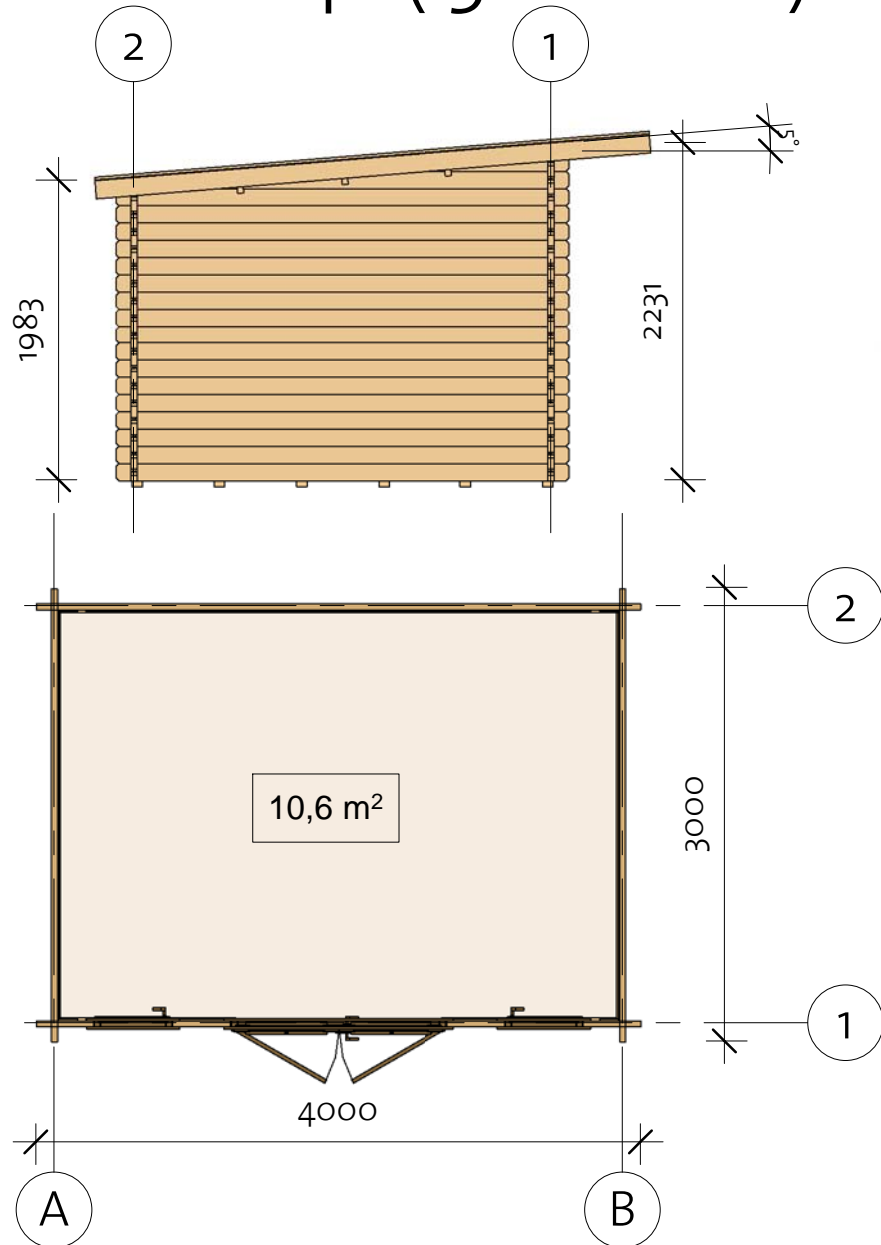

# Placas II 40( 380x280)

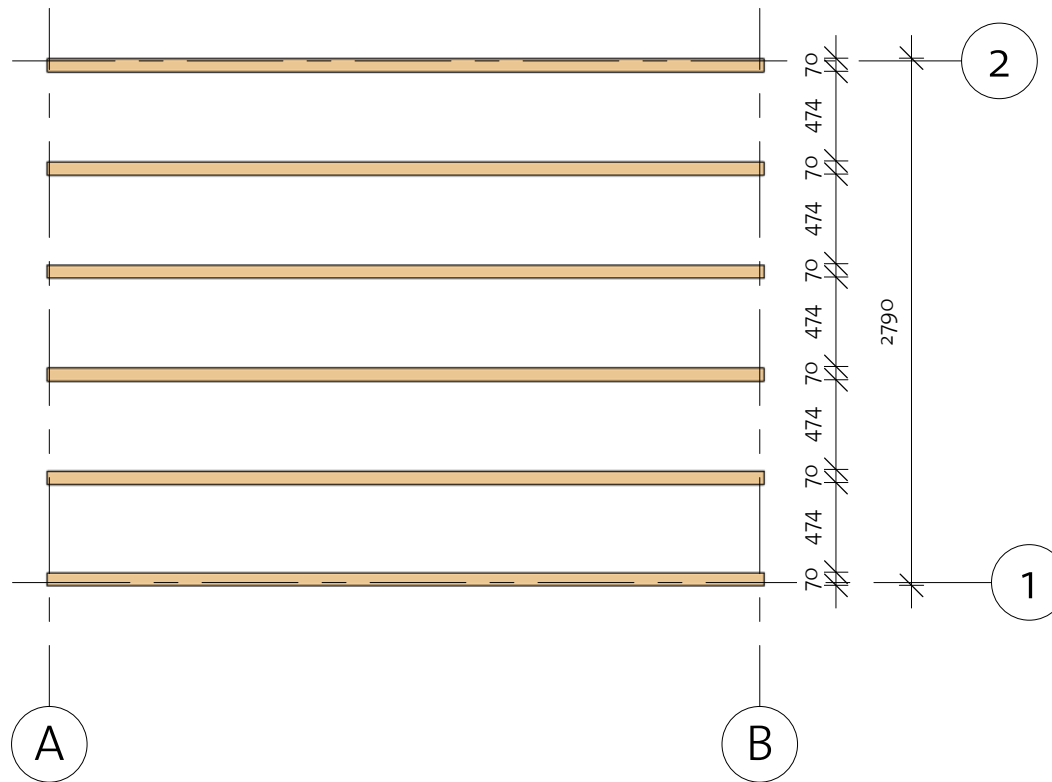

# Placas II 40( 380x280)

Foundation



| Impregnated foundation beams |              |   |       |        |
|------------------------------|--------------|---|-------|--------|
| Mark                         | Type         | Profile   | Count | Length |
| IFB                          | IFB<br>70x40 |  | 6     | 3790   |



# Placas II 40( 380x280)

Floor Plan

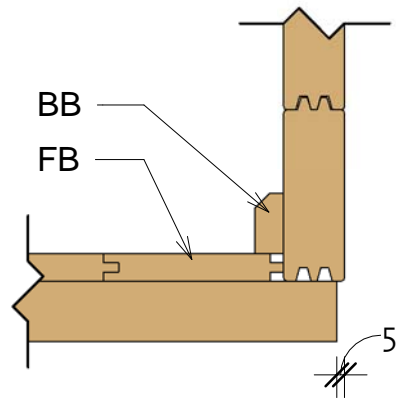
① Baseboard



Floor Schedule

| Mark | Type      | Profile   | Count | Length |
|------|-----------|---|-------|--------|
| FB   | FB 18x110 |  | 35    | 2717   |
| BB1  | BB 20x40  |  | 2     | 3800   |
| BB2  | BB 20x40  |   | 2     | 2800   |

190828

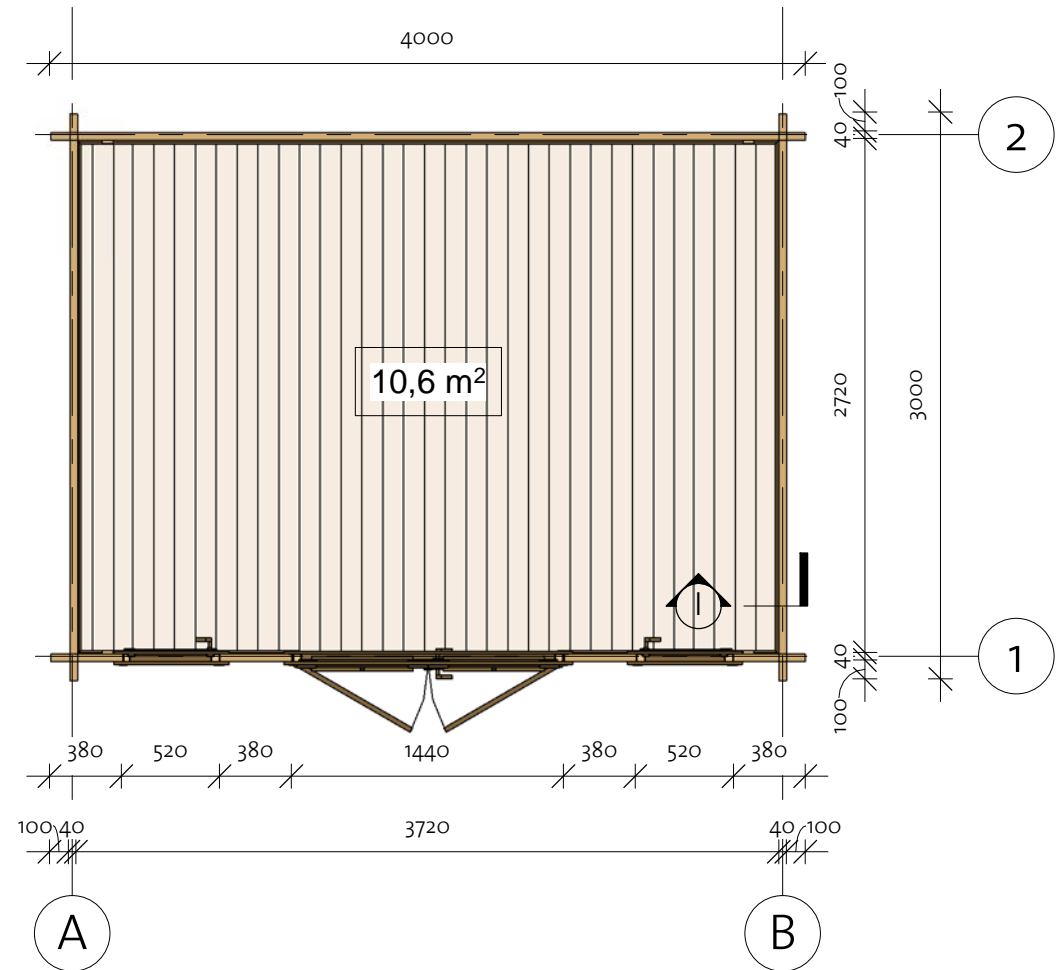

# Placas II 40(380x280)

Wall 1

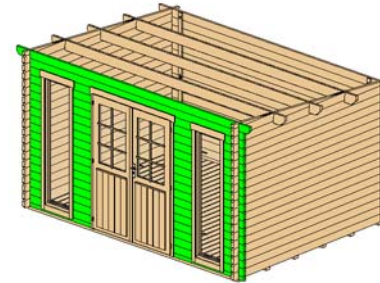

| Wall 1 |         |       |            |
|--------|---------|-------|------------|
| Mark   | Profile | Count | Cut Length |

|       |        |    |      |
|-------|--------|----|------|
| 1BL-1 | 40x57  | 2  | 1280 |
| 1LG-1 | 40x114 | 34 | 380  |
| 1LG-2 | 40x114 | 34 | 380  |
| 1LG-3 | 40x114 | 1  | 4000 |
| 1TL-1 | 40x114 | 1  | 4200 |

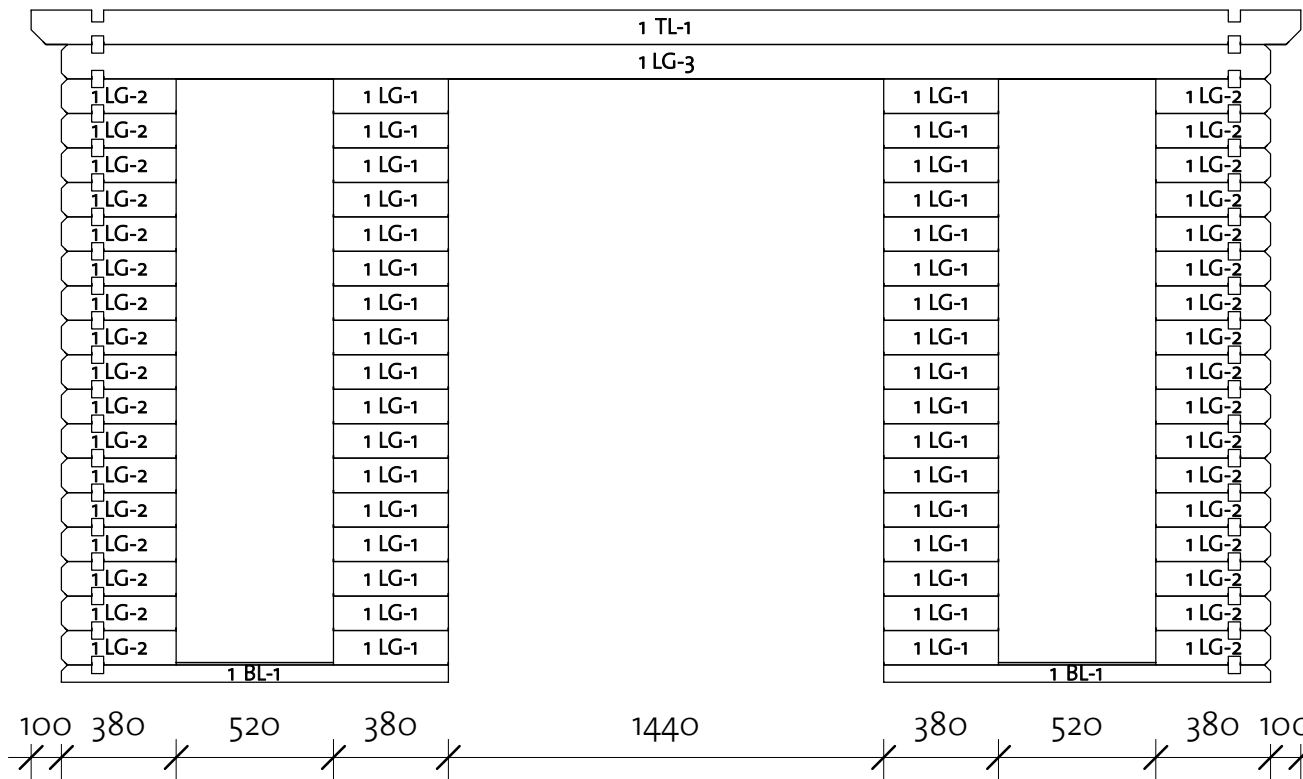

| Log Profile Wall 1 |         |
|--------------------|---------|
| Profile            | Profile |

|        |  |
|--------|--|
| 40x57  |  |
| 40x114 |  |
| 40x114 |  |



# Placas II 40( 380x280)

Wall A

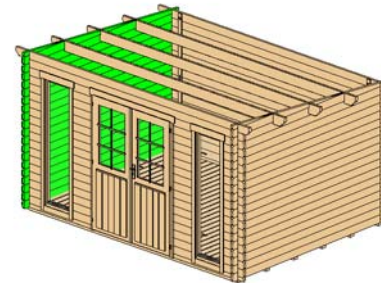

| Wall A |         |       |            |
|--------|---------|-------|------------|
| Mark   | Profile | Count | Cut Length |

|       |        |    |      |
|-------|--------|----|------|
| ALG-1 | 40x114 | 17 | 3000 |
| ALG-2 | 40x114 | 1  | 3000 |
| ALG-3 | 40x114 | 1  | 2166 |
| ALG-4 | 40x114 | 1  | 787  |

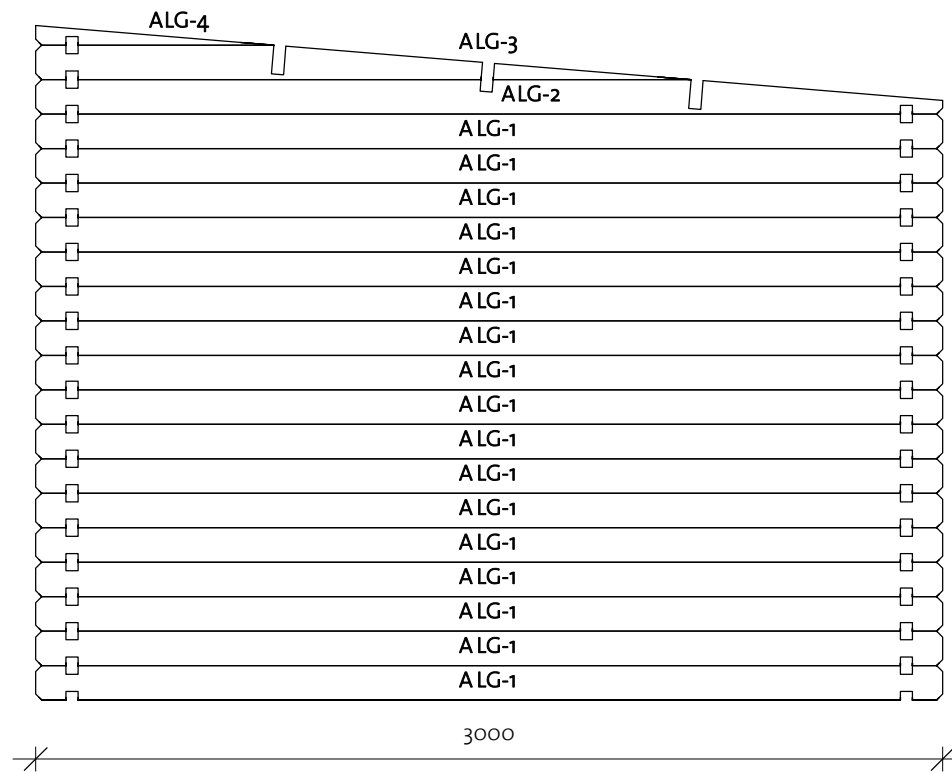

| Log Profile Wall A |         |
|--------------------|---------|
| Profile            | Profile |

|        |  |
|--------|--|
| 40X114 |  |
|--------|--|

# Placas II 40( 380x280)

Wall B

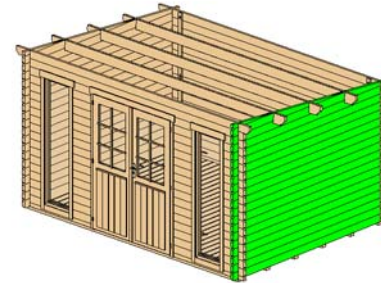

| Wall B |         |       |            |
|--------|---------|-------|------------|
| Mark   | Profile | Count | Cut Length |

|       |        |    |      |
|-------|--------|----|------|
| BLG-1 | 40x114 | 17 | 3000 |
| BLG-2 | 40x114 | 1  | 3000 |
| BLG-3 | 40x114 | 1  | 2166 |
| BLG-4 | 40x114 | 1  | 787  |

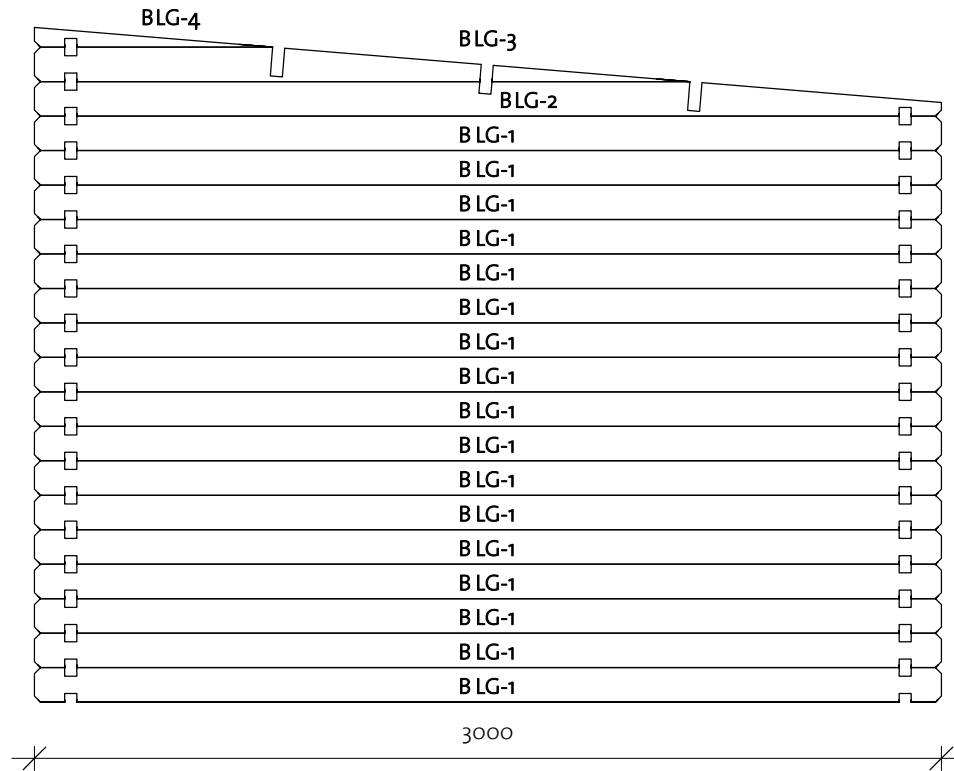



| Log Profile Wall B |         |
|--------------------|---------|
| Profile            | Profile |

|        |   |
|--------|---|
| 40x114 |  |
|--------|---|

# Placas II 40(380x280)

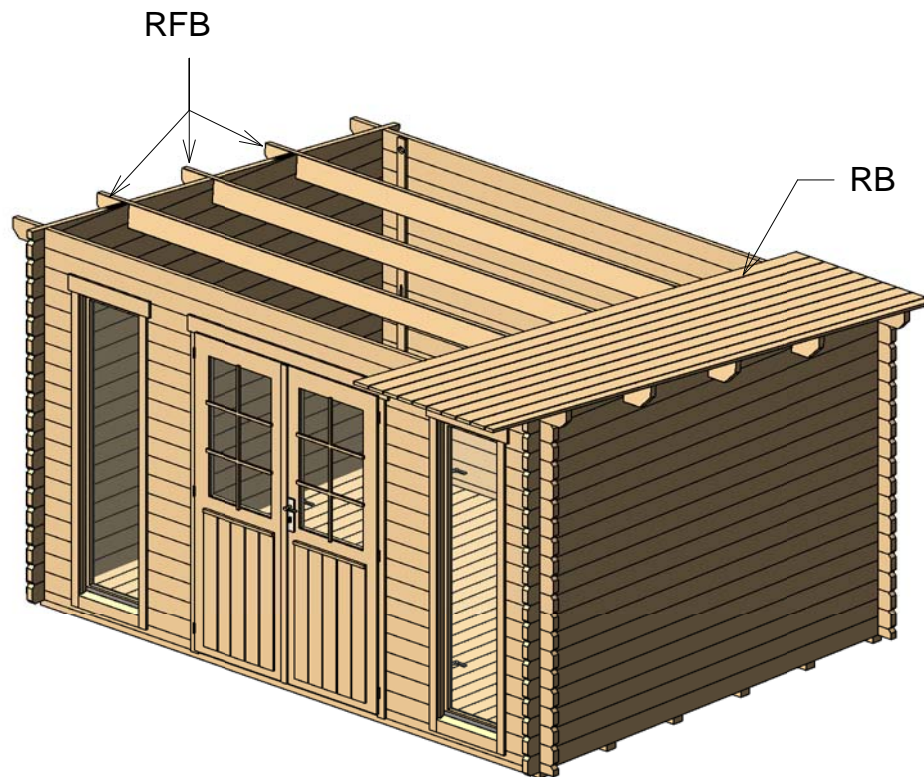
Roof 1



| Roof |                |   |       |        |
|------|----------------|---|-------|--------|
| Mark | Type           | Profile   | Count | Length |
| RFB  | Beam<br>40x143 |  | 3     | 4200   |
| RB   | 18x110         |  | 40    | 3620   |



# Placas II 40(380x280)

Roof 2

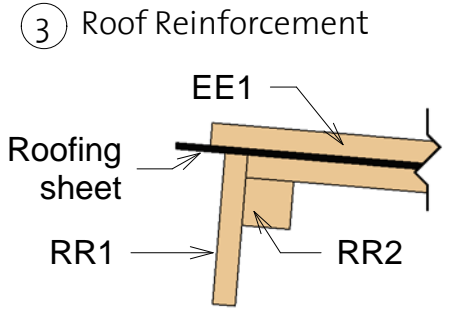
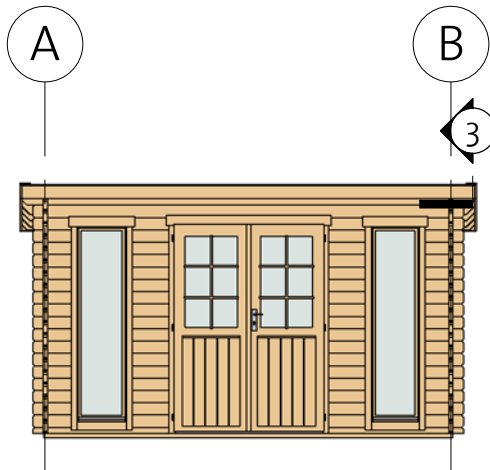
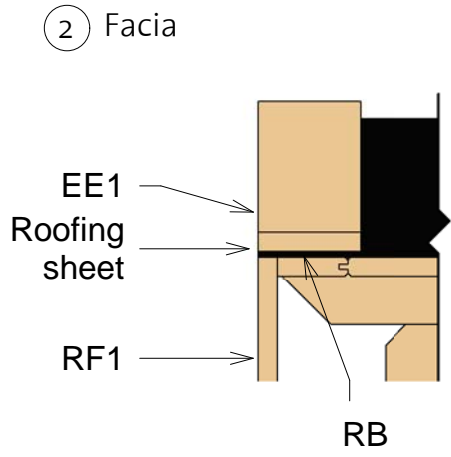
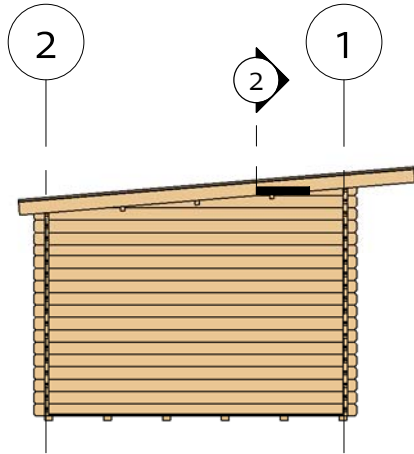

| Fascia Schedule |      |         |       |        |
|-----------------|------|---------|-------|--------|
| Mark            | Type | Profile | Count | Length |

|     |                           |  |   |      |
|-----|---------------------------|--|---|------|
| RR1 | Roof reinforcement 18x120 |  | 2 | 4200 |
| RR2 | Roof reinforcement 38x38  |  | 2 | 4200 |
| RF1 | Roof Fascia 18x120        |  | 2 | 3680 |
| EE1 | Eave Edging 18x95         |  | 2 | 3680 |

# Placas II 40( 380x280)

Extras



| Door Schedule |                                |       |        |       |
|---------------|--------------------------------|-------|--------|-------|
| Mark          | Type                           | Width | Height | Count |
| CDD1R         | Classic double door<br>1 right | 1425  | 1955   | 1     |
| DCB6          | Door Crossbar 6                | --    | --     | 2     |

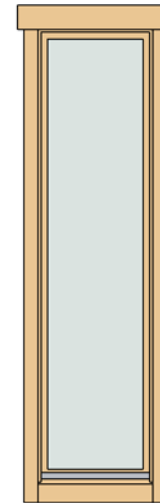

| Window Schedule |                                       |       |        |       |
|-----------------|---------------------------------------|-------|--------|-------|
| Mark            | Type                                  | Width | Height | Count |
| CW3L            | Classic window 3,<br>full glass left  | 515   | 1890   | 1     |
| CW3R            | Classic window 3,<br>full glass right | 515   | 1890   | 1     |

| Fasteners & Extras |      |       |
|--------------------|------|-------|
| Name               | Type | Count |

|          |            |     |
|----------|------------|-----|
| Hitblock | 300-400 mm |     |
| Bolts    | M8 x 70    | 12  |
| Screws   | 5,0 x 70   | 15  |
| Nails    | 1,4 x 40   | 25  |
| Screws   | 6,0 x 140  | 40  |
| Screws   | 4,0 x 40   | 70  |
| Screws   | 4,0 x 50   | 450 |



| Type | Length | Count |
|------|--------|-------|
|------|--------|-------|

|                    |      |   |
|--------------------|------|---|
| Windboard<br>18x38 | 2200 | 4 |
|--------------------|------|---|

190828

# Placas II 40( 380x280)

## List of all items 1

### Impregnated foundation beams

| Mark | Type | Profile | Count | Length |
|------|------|---------|-------|--------|
|------|------|---------|-------|--------|

|     |              |   |   |      |
|-----|--------------|---|---|------|
| IFB | IFB<br>70x40 |  | 6 | 3790 |
|-----|--------------|---|---|------|

### Floor Schedule

| Mark | Type | Profile | Count | Length |
|------|------|---------|-------|--------|
|------|------|---------|-------|--------|

|    |           |   |    |      |
|----|-----------|---|----|------|
| FB | FB 18x110 |  | 35 | 2717 |
|----|-----------|---|----|------|

|     |             |   |   |      |
|-----|-------------|---|---|------|
| BB1 | BB<br>20x40 |  | 2 | 3800 |
|-----|-------------|---|---|------|

|     |             |  |   |      |
|-----|-------------|--|---|------|
| BB2 | BB<br>20x40 |  | 2 | 2800 |
|-----|-------------|--|---|------|

### Roof

| Mark | Type | Profile | Count | Length |
|------|------|---------|-------|--------|
|------|------|---------|-------|--------|

|     |                |   |   |      |
|-----|----------------|---|---|------|
| RFB | Beam<br>40x143 |  | 3 | 4200 |
|-----|----------------|---|---|------|

|    |        |   |    |      |
|----|--------|---|----|------|
| RB | 18x110 |  | 40 | 3620 |
|----|--------|---|----|------|

### Fascia Schedule

| Mark | Type | Profile | Count | Length |
|------|------|---------|-------|--------|
|------|------|---------|-------|--------|

|     |                                 |   |   |      |
|-----|---------------------------------|---|---|------|
| RR1 | Roof<br>reinforcement<br>18x120 |  | 2 | 4200 |
|-----|---------------------------------|---|---|------|

|     |                                |   |   |      |
|-----|--------------------------------|---|---|------|
| RR2 | Roof<br>reinforcement<br>38x38 |  | 2 | 4200 |
|-----|--------------------------------|---|---|------|

|     |                       |   |   |      |
|-----|-----------------------|---|---|------|
| RF1 | Roof Fascia<br>18x120 |  | 2 | 3680 |
|-----|-----------------------|---|---|------|

|     |                      |   |   |      |
|-----|----------------------|---|---|------|
| EE1 | Eave Edging<br>18x95 |  | 2 | 3680 |
|-----|----------------------|---|---|------|

# Placas II 40( 380x280)

## List of all items 2

| Wall 1 |         |       |            |
|--------|---------|-------|------------|
| Mark   | Profile | Count | Cut Length |

|       |        |    |      |
|-------|--------|----|------|
| 1BL-1 | 40x57  | 2  | 1280 |
| 1LG-1 | 40x114 | 34 | 380  |
| 1LG-2 | 40x114 | 34 | 380  |
| 1LG-3 | 40x114 | 1  | 4000 |
| 1TL-1 | 40x114 | 1  | 4200 |

| Wall 2 |         |       |            |
|--------|---------|-------|------------|
| Mark   | Profile | Count | Cut Length |

|       |        |    |      |
|-------|--------|----|------|
| 2BL-1 | 40x57  | 1  | 4000 |
| 2LG-1 | 40x114 | 16 | 4000 |
| 2TL-1 | 40x114 | 1  | 4200 |



| Wall A |         |       |            |
|--------|---------|-------|------------|
| Mark   | Profile | Count | Cut Length |

|       |        |    |      |
|-------|--------|----|------|
| ALG-1 | 40x114 | 17 | 3000 |
| ALG-2 | 40x114 | 1  | 3000 |
| ALG-3 | 40x114 | 1  | 2166 |
| ALG-4 | 40x114 | 1  | 787  |

| Wall B |         |       |            |
|--------|---------|-------|------------|
| Mark   | Profile | Count | Cut Length |

|       |        |    |      |
|-------|--------|----|------|
| BLG-1 | 40x114 | 17 | 3000 |
| BLG-2 | 40x114 | 1  | 3000 |
| BLG-3 | 40x114 | 1  | 2166 |
| BLG-4 | 40x114 | 1  | 787  |

| Log Profiles |         |
|--------------|---------|
| Profile      | Profile |

|        |   |
|--------|---|
| 40x57  |  |
| 40x114 |  |

| Log Profiles |         |
|--------------|---------|
| Profile      | Profile |

|        |   |
|--------|---|
| 40x114 |  |
|--------|---|