

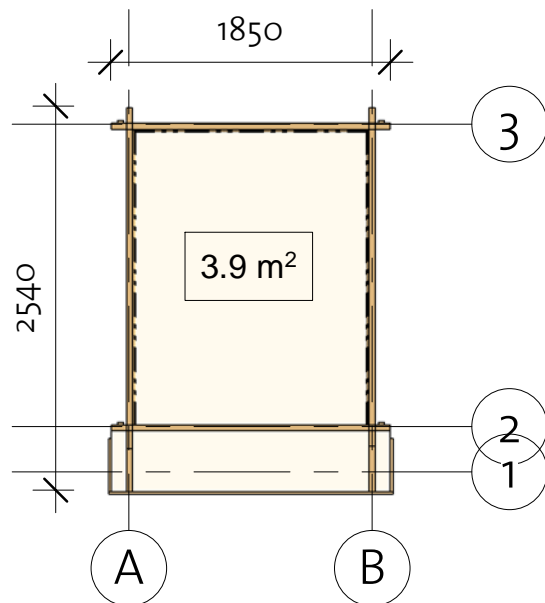

Sleeping Shelter 40 (185x254)

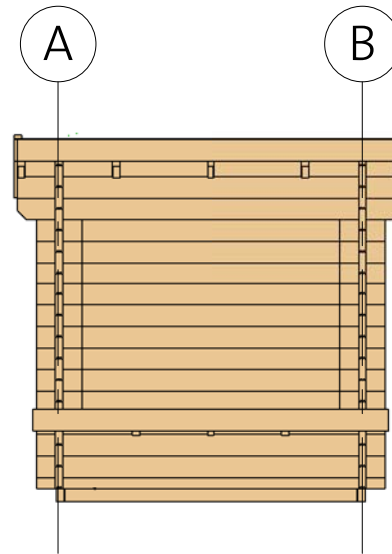
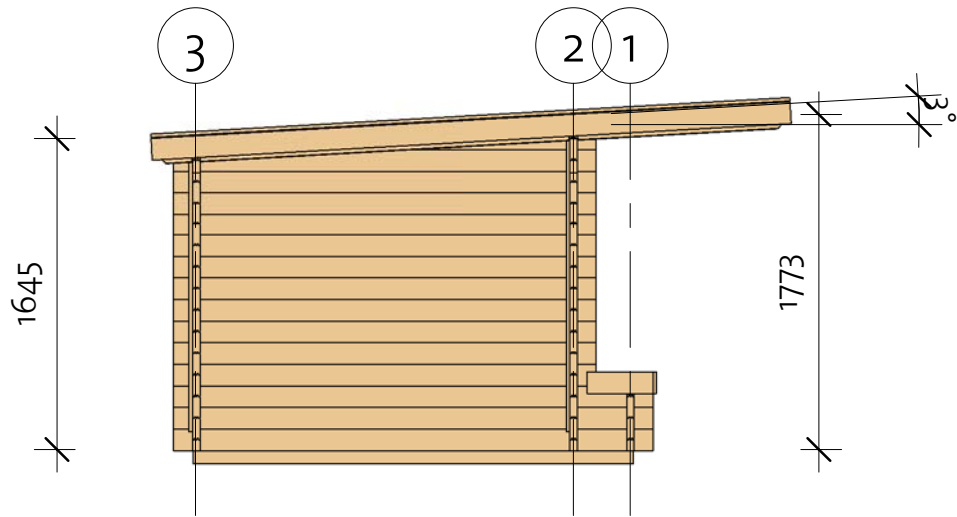
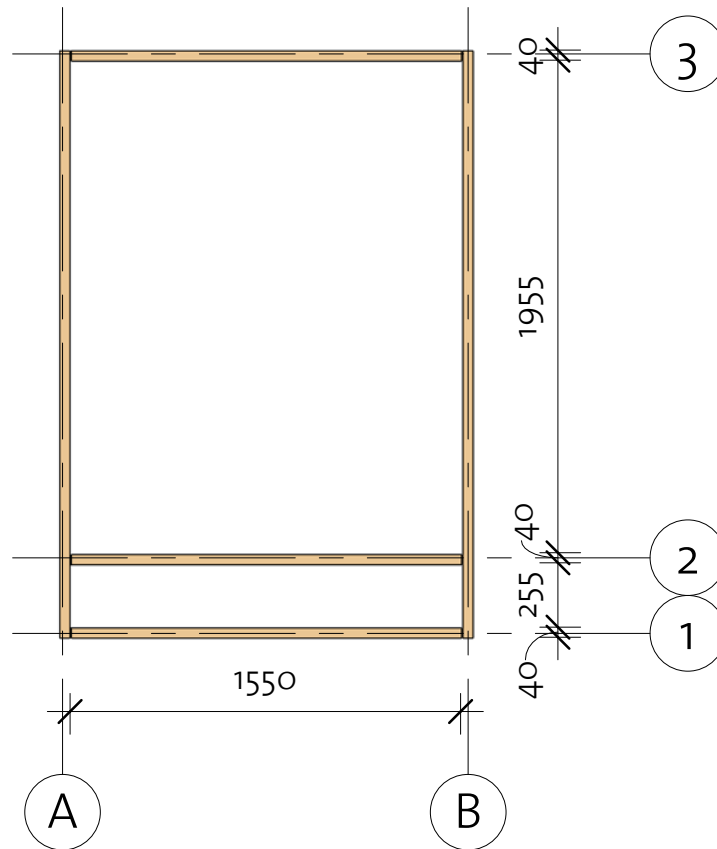

Sleeping Shelter 40 (185x254)

Foundation



Impregnated foundation beams				
Mark	Type	Profile	Count	Length
IFB1	IFB 40x70		3	1550
IFB2	IFB 40x70		2	2330

Sleeping Shelter 40 (185x254)

Floor Plan

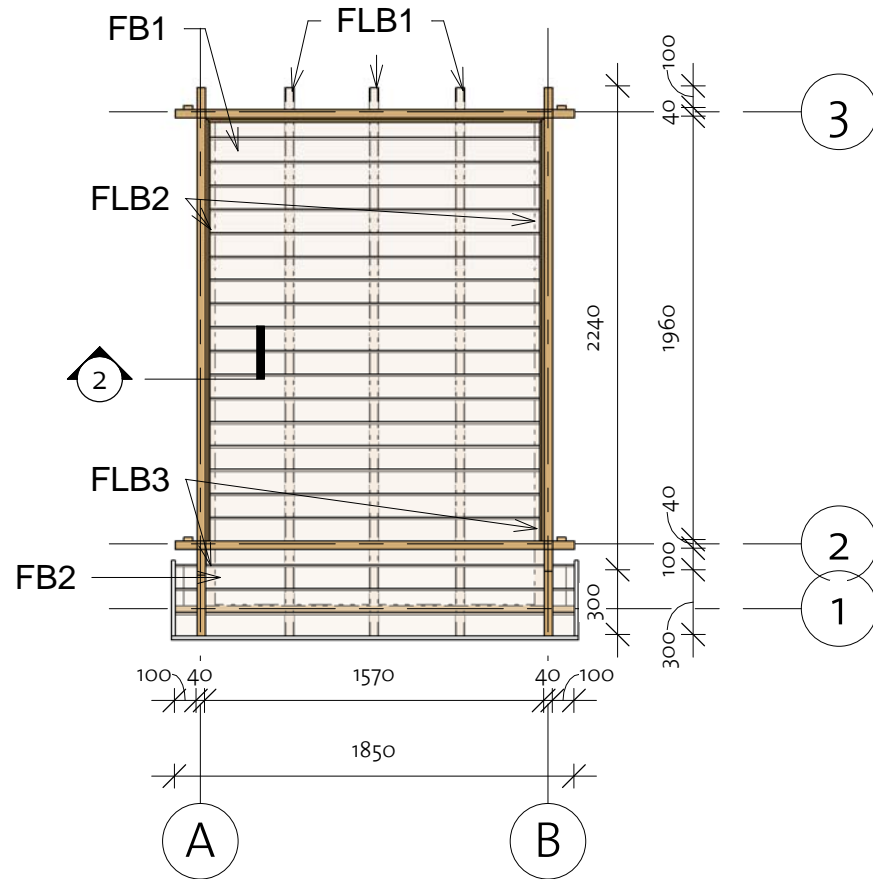

BB1	BB 20X40		1	1700
BB2	BB 20X40		2	2000

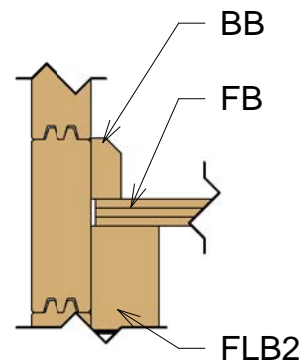

Floor Schedule				
Mark	Type	Profile	Count	Length

FB1	FB 18x110		20	1567
FB2	FB 18x110		4	1850
FLB1	Floor beam 40X120		3	2540
FLB2	Floor beam 45X70		2	1960
FLB3	Floor beam 45X70		2	260

Sleeping Shelter 40 (185x254)

Wall 1

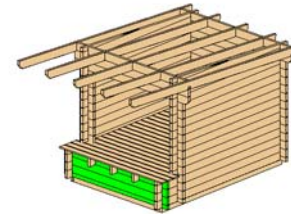

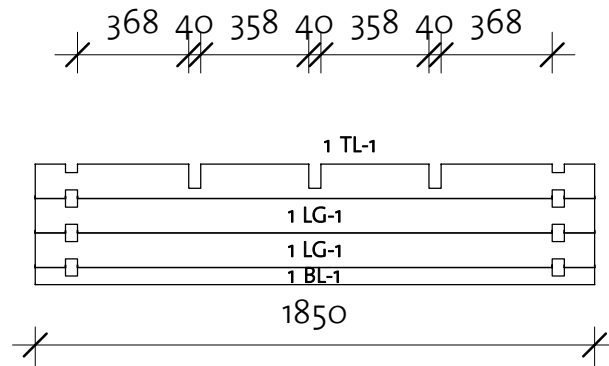

Wall 1			
Mark	Profile	Count	Cut Length

1BL-1	40x57	1	1850
1LG-1	40x114	2	1850
1TL-1	40x114	1	1850



Log Profile Wall 1	
Profile	Profile

40x57	
40x114	
40x114	

Sleeping Shelter 40 (185x254)

Wall 2

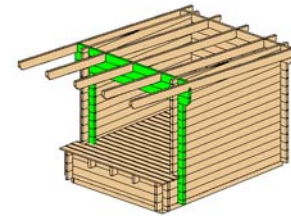

Wall 2			
Mark	Profile	Count	Cut Length

2BL-1	40x57	1	1850
2LG-1	40x114	18	240
2LG-2	40x114	2	1850
2LG-3	40x114	1	1850
2LG-4	40x114	1	2050
2LG-5	40x114	1	2050
2TL-1	40x114	1	2050

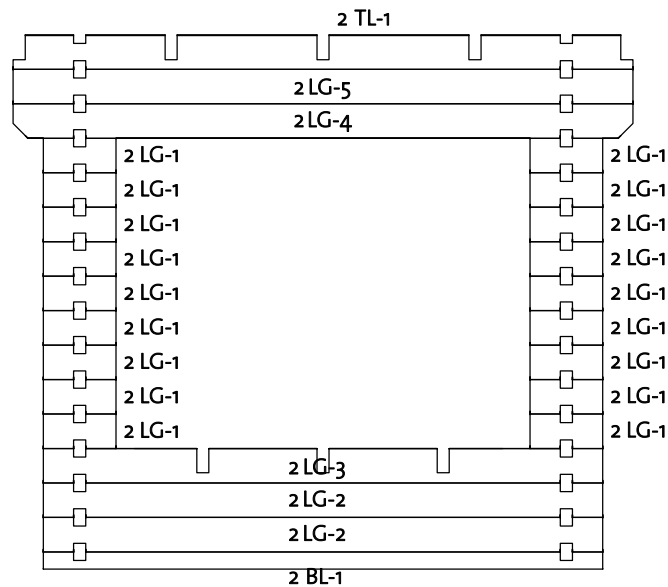

Log Profile Wall 2	
Profile	Profile

40x57	
40x114	
40x114	

Sleeping Shelter 40 (185x254)

Wall 3

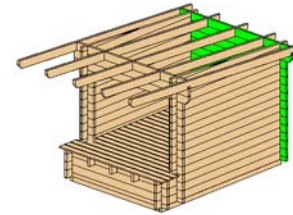

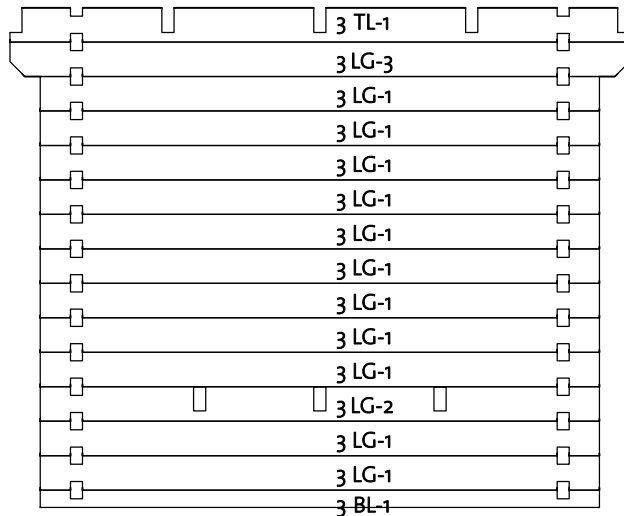

Wall 3			
Mark	Profile	Count	Cut Length

3BL-1	40x57	1	1850
3LG-1	40x114	11	1850
3LG-2	40x114	1	1850
3LG-3	40x114	1	2050
3TL-1	40x114	1	2050



Log Profile Wall 3	
Profile	Profile

40x57	
40x114	
40x114	

Sleeping Shelter 40 (185x254)

Wall A

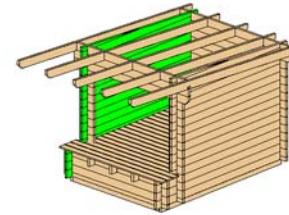

Wall A			
Mark	Profile	Count	Cut Length

ALG-1	40x114	1	1100
ALG-2	40x114	1	2240
ALG-3	40x114	10	2240
ALG-4	40x114	1	2540
ALG-5	40x114	3	2540

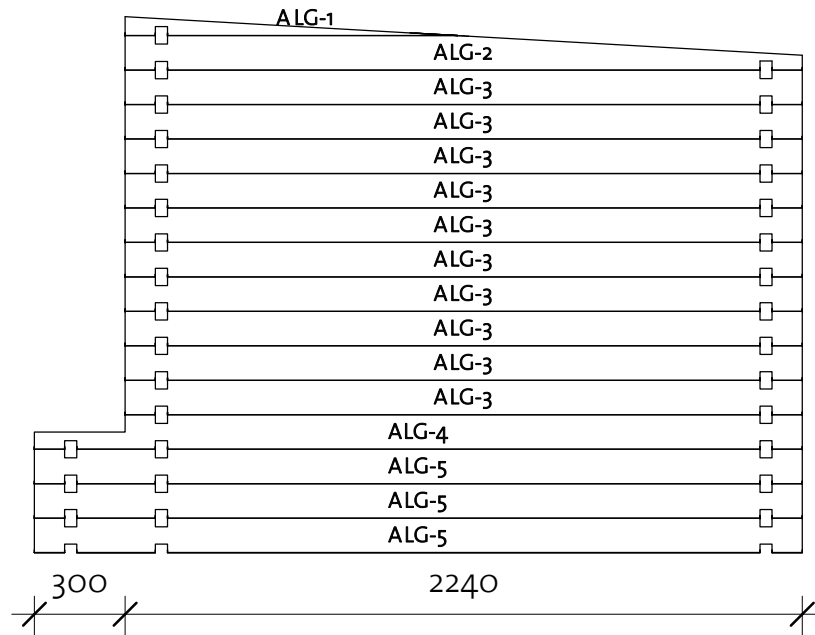

Log Profile Wall A	
Profile	Profile

40x114	
--------	--

Sleeping Shelter 40 (185x254)

Wall B

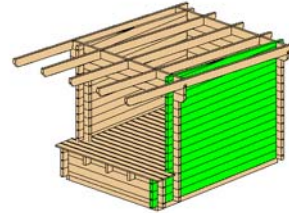

Wall B			
Mark	Profile	Count	Cut Length

BLG-1	40x114	1	1100
BLG-2	40x114	1	2240
BLG-3	40x114	10	2240
BLG-4	40x114	1	2540
BLG-5	40x114	3	2540

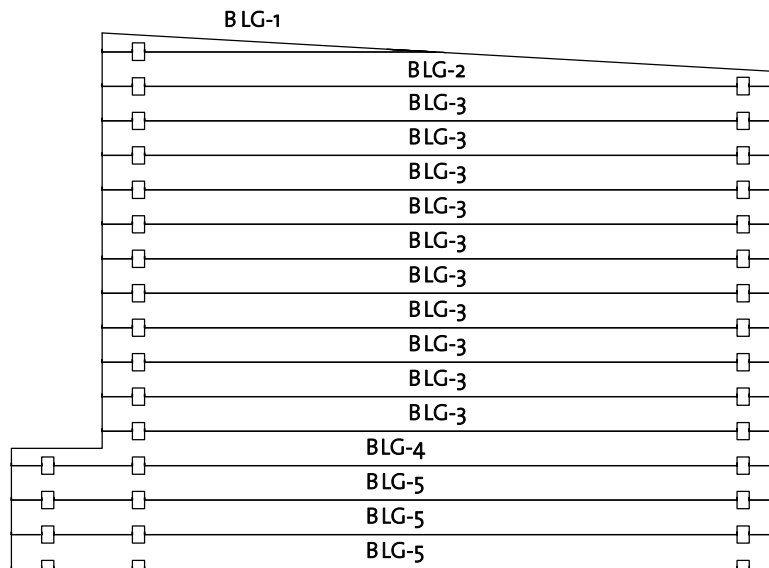

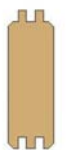

Log Profile Wall B	
Profile	Profile

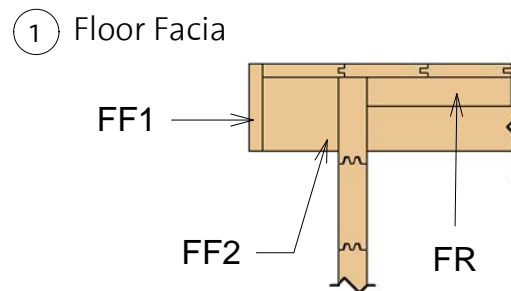
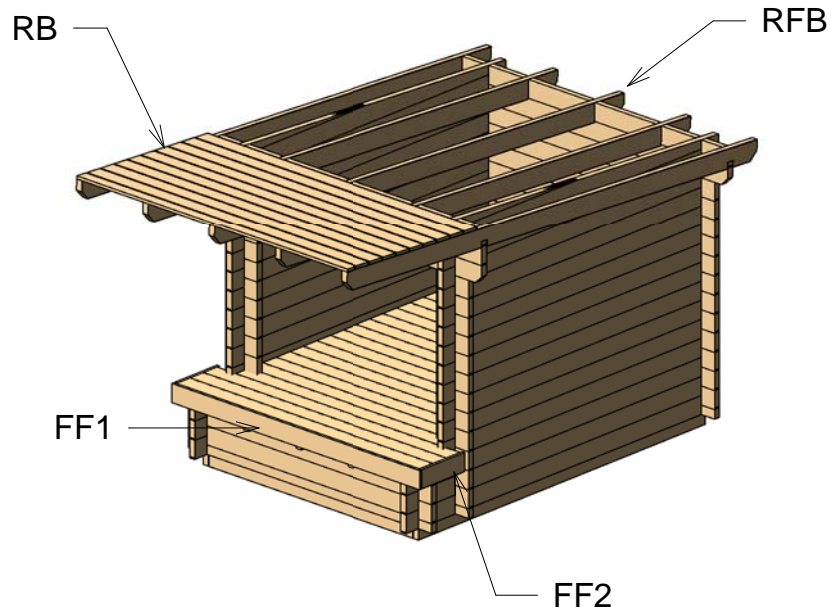

40x114	
--------	---

Sleeping Shelter 40 (185x254)

Roof 1



Roof				
Mark	Type	Profile	Count	Length
RFB	Beam 40x120		5	3350
RB	18x110		32	2050

Floor Facia				
Mark	Type	Profile	Count	Length
FF1	Floor Fascia 18x115		1	1886
FF2	Floor Fascia 18x115		2	350
FR	Floor reinforcement 38x38		2	190

Sleeping Shelter 40 (185x254)

Roof 2

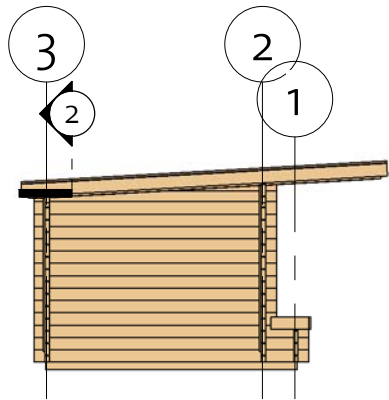

② Facia

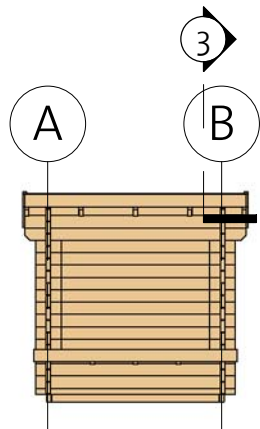
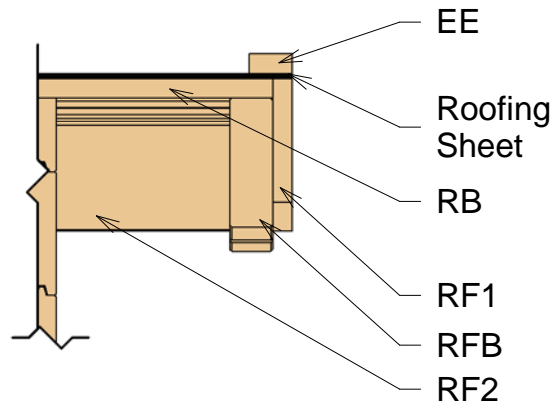

③ Roof Reinforcement

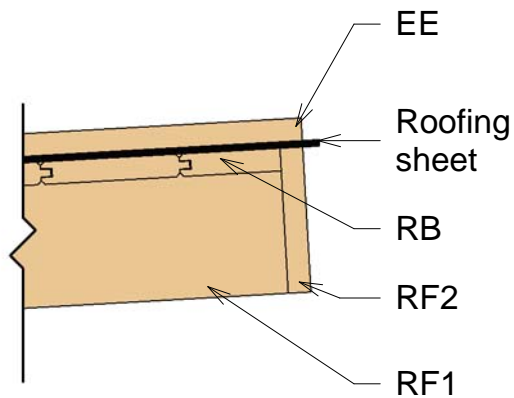

Fascia Schedule				
Mark	Type	Profile	Count	Length
EE	Eave Edging 18x40		2	3386
RF1	Roof Fascia 18x115		2	3386
RF2	Roof Fascia 18x115		2	2050

Sleeping Shelter 40 (185x254)

Extras

Fasteners/Extras		
Name	Type	Count

Hitblock	300-400 mm	
Bolts	M8x70	12
Nails	1,4 x 40	15
Screws	5,0x 70	35
Screws	4,0 x 40	50
Screws	6,0 x 140	50
Screws	4,0 x 50	320







Type	Count	Length
------	-------	--------





Windboard 2 18x40	2	1520
Windboard1 18x40	2	1650

Sleeping Shelter 40 (185x254)

List of all items 1



Roof				
Mark	Type	Profile	Count	Length
RFB	Beam 40x120		5	3350
RB	18x110		32	2050



Fascia Schedule				
Mark	Type	Profile	Count	Length
EE	Eave Edging 18x40		2	3386
RF1	Roof Fascia 18x115		2	3386
RF2	Roof Fascia 18x115		2	2050

Floor Schedule				
Mark	Type	Profile	Count	Length
FB1	FB 18x110		20	1567
FB2	FB 18x110		4	1850
FLB1	Floor beam 40x120		3	2540
FLB2	Floor beam 45x70		2	1960
FLB3	Floor beam 45x70		2	260

Sleeping Shelter 40 (185x254)

List of all items 2

Floor Fascia				
Mark	Type	Profile	Count	Length
FF1	Floor Fascia 18x115		1	1886
FF2	Floor Fascia 18x115		2	350
FR	Floor reinforcement 38x38		2	190

Impregnated foundation beams				
Mark	Type	Profile	Count	Length
IFB1	IFB 40x70		3	1550
IFB2	IFB 40x70		2	2330

Sleeping Shelter 40 (185x254)

List of all items 3

Wall 1			
Mark	Profile	Count	Cut Length

1BL-1	40x57	1	1850
1LG-1	40x114	2	1850
1TL-1	40x114	1	1850

Wall 2			
Mark	Profile	Count	Cut Length

2BL-1	40x57	1	1850
2LG-1	40x114	18	240
2LG-2	40x114	2	1850
2LG-3	40x114	1	1850
2LG-4	40x114	1	2050
2LG-5	40x114	1	2050
2TL-1	40x114	1	2050

Wall A			
Mark	Profile	Count	Cut Length

ALG-1	40x114	1	1100
ALG-2	40x114	1	2240
ALG-3	40x114	10	2240
ALG-4	40x114	1	2540
ALG-5	40x114	3	2540



Wall B			
Mark	Profile	Count	Cut Length

BLG-1	40x114	1	1100
BLG-2	40x114	1	2240
BLG-3	40x114	10	2240
BLG-4	40x114	1	2540
BLG-5	40x114	3	2540

Wall 3			
Mark	Profile	Count	Cut Length

3BL-1	40x57	1	1850
3LG-1	40x114	11	1850
3LG-2	40x114	1	1850
3LG-3	40x114	1	2050
3TL-1	40x114	1	2050

Log Profiles	
Profile	Profile

40x57	
40x114	

Log Profiles	
Profile	Profile

40x114	
40x114	