

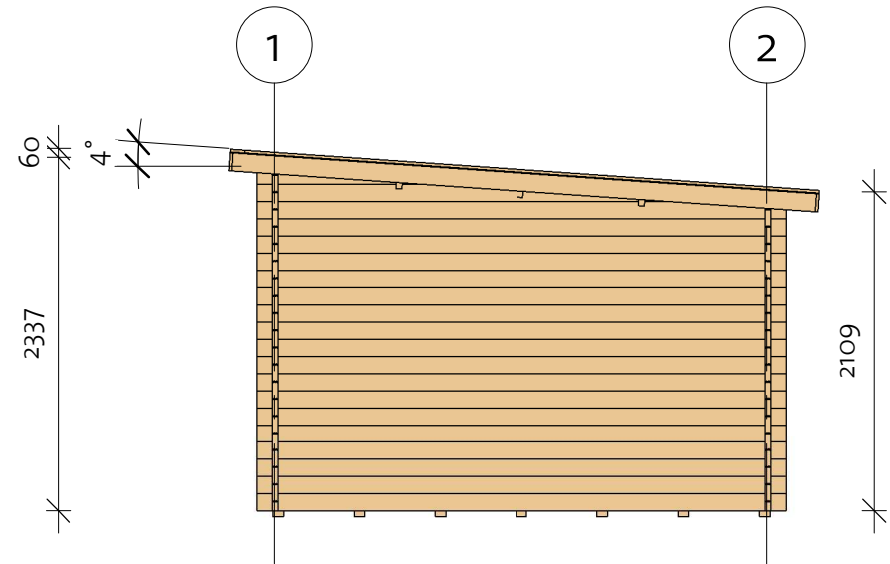

Jody 40 (450x330)

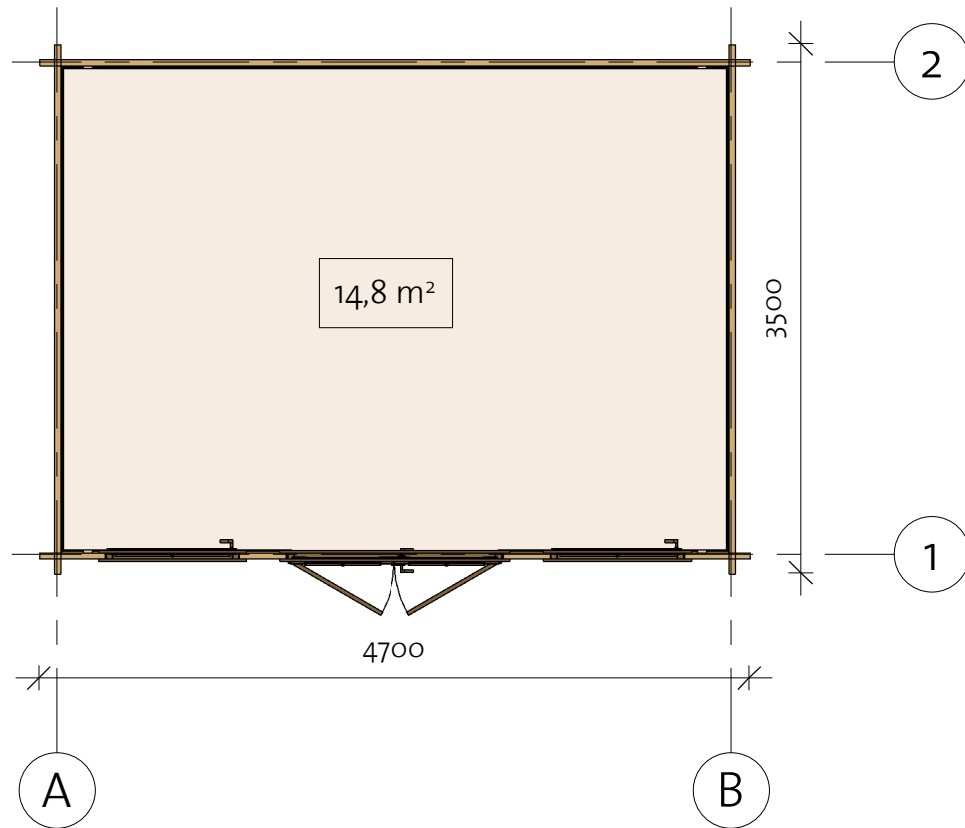
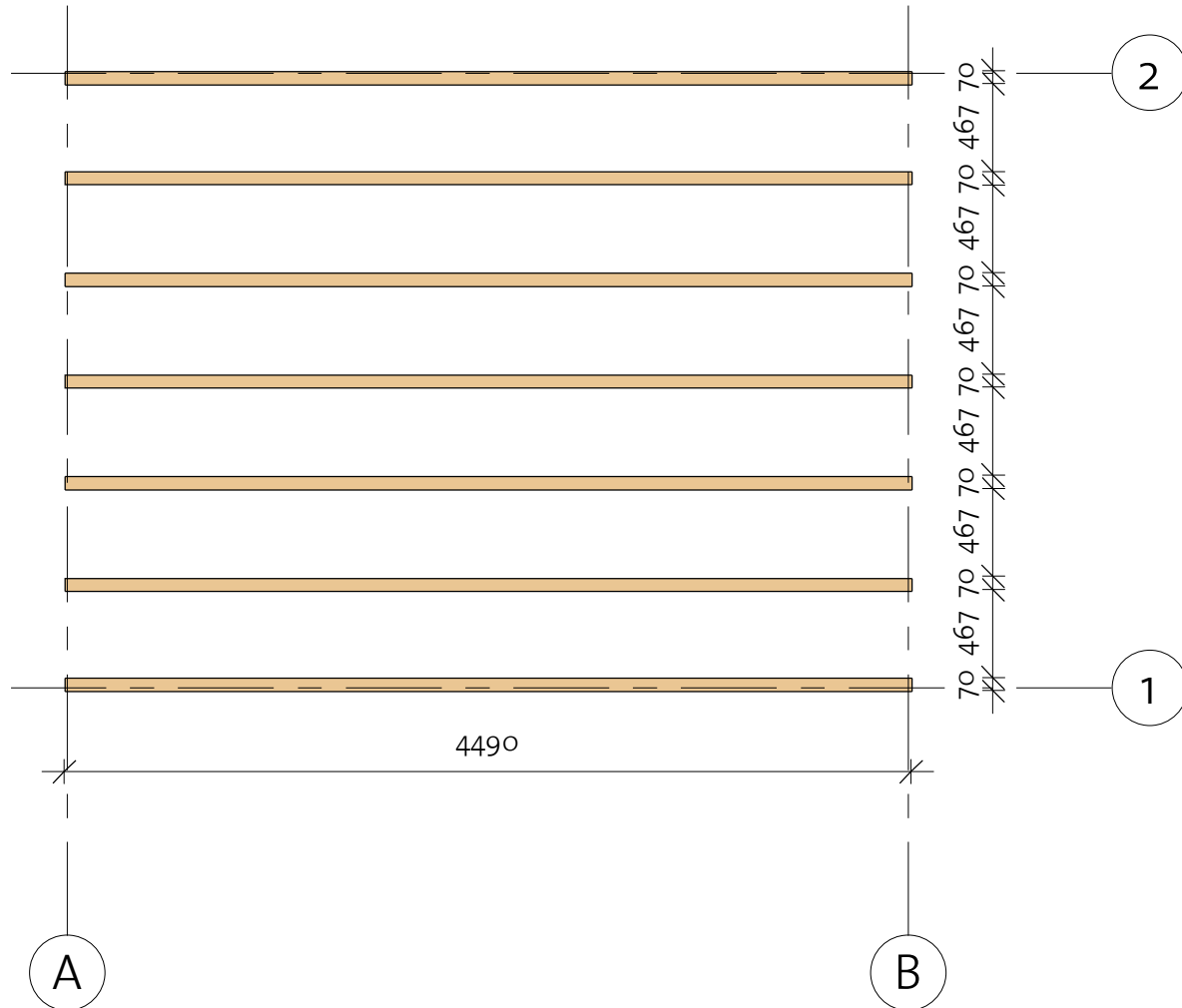

Jody 40 (450x330)

Foundation



Impregnated foundation beams				
Mark	Type	Profile	Count	Length
IFB	IFB 70x40		7	4490



Jody 40 (450x330)

Floor Plan

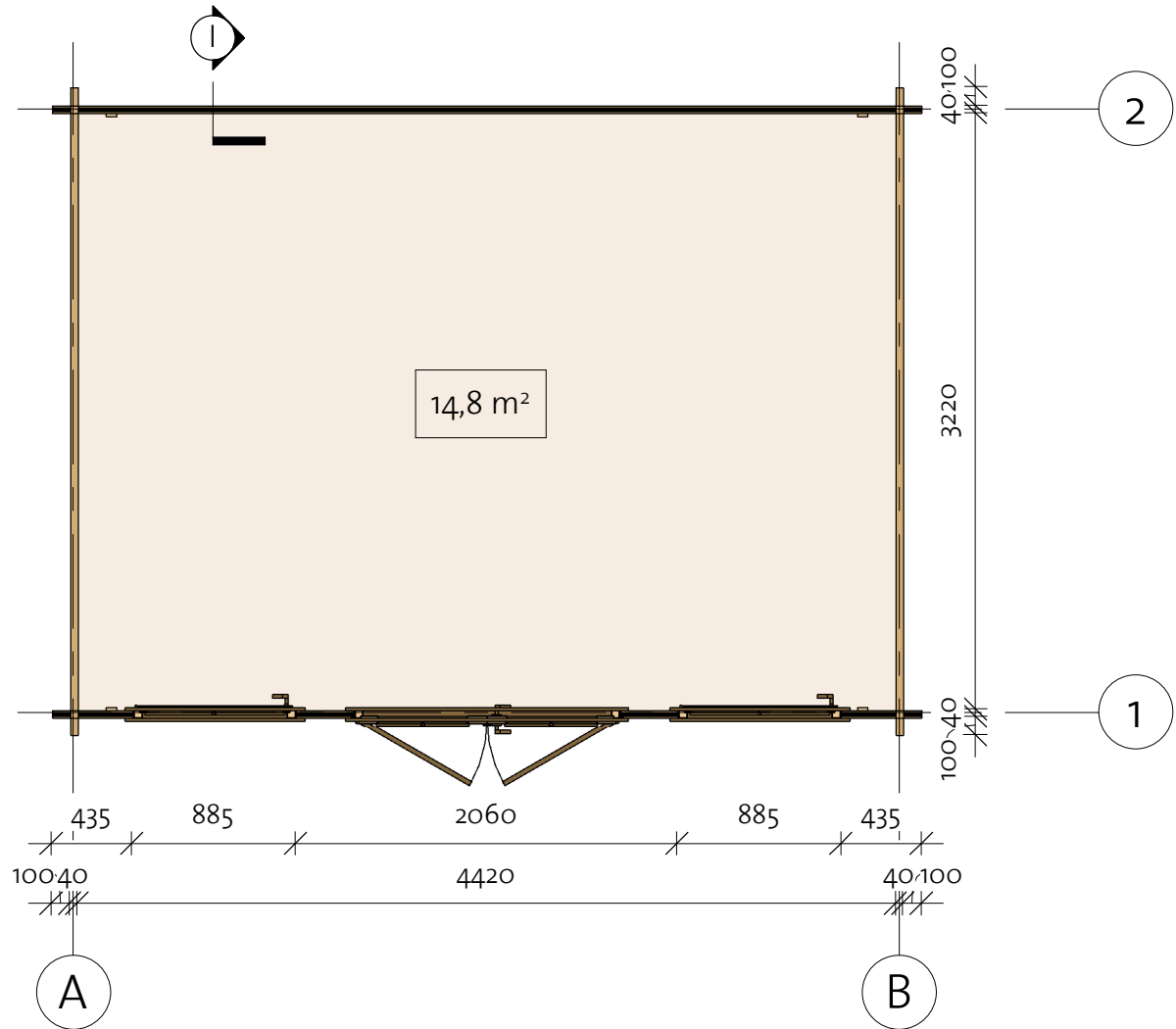
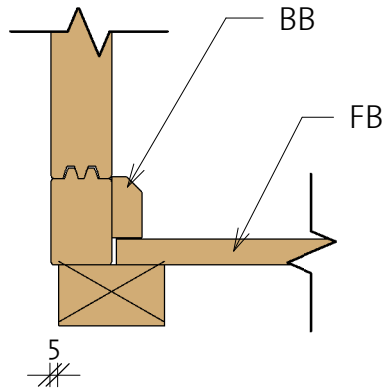
① Baseboard



Floor Schedule

Mark	Type	Profile	Count	Length
FB	FB 17x114		40	3214
BB1	BB 20x40		2	4500
BB2	BB 20x40		2	3300

91923052_211206

Jody 40 (450x330)

Wall 1

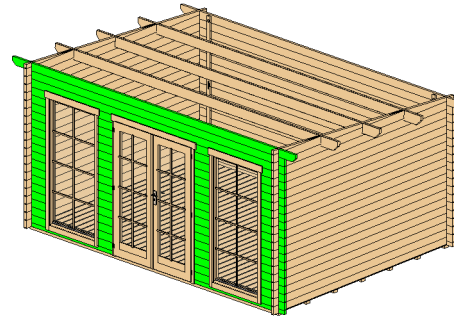

Wall 1			
Mark	Profile	Count	Cut Length

1BL-1	40x57	2	1630
1LG-1	40x114	34	310
1LG-2	40x114	34	435
1LG-3	40x114	2	4700
1TL-1	40x114	1	5100

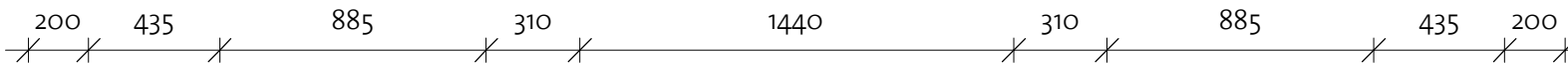
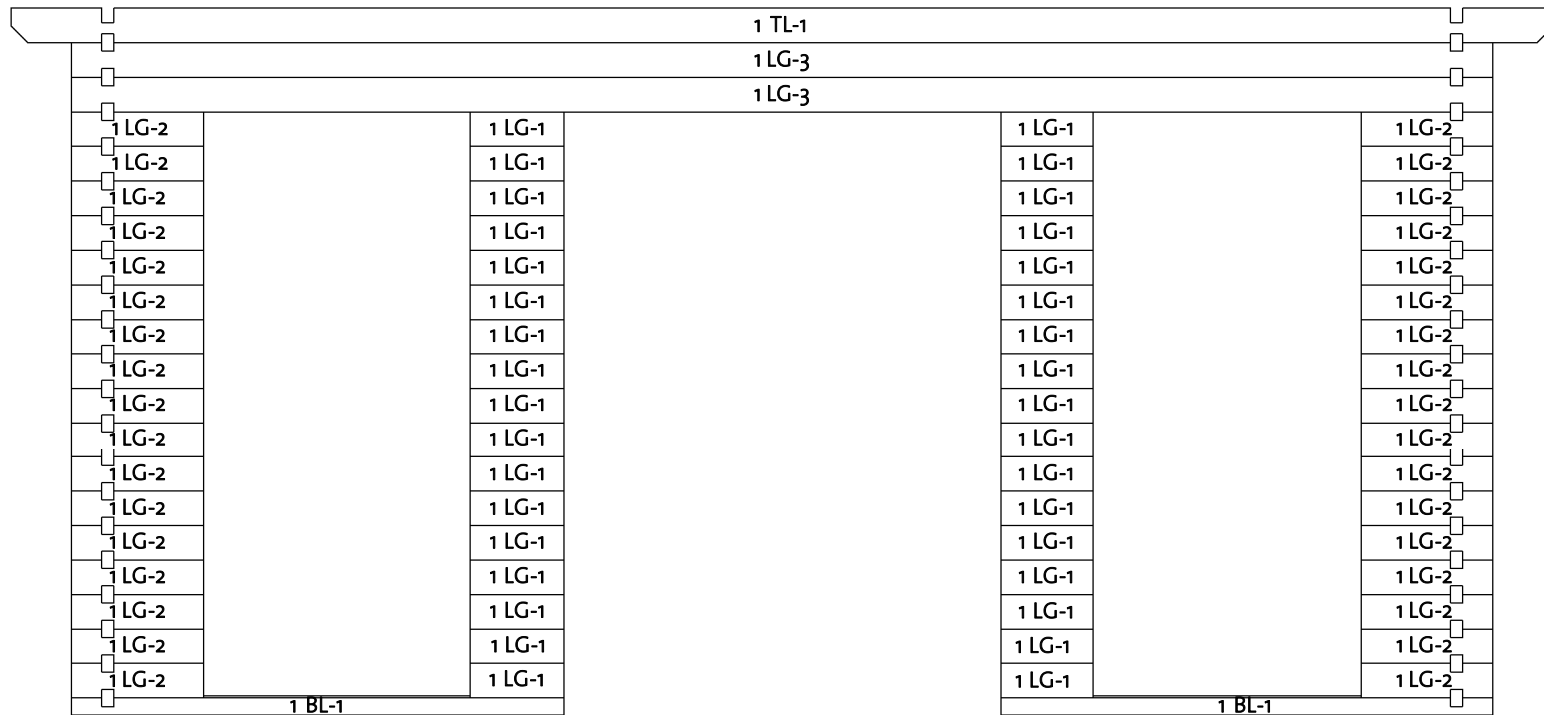

Log Profile Wall 1	
Profile	Profile

40x57	
40x114	
40x114	

Jody 40 (450x330)

Wall A

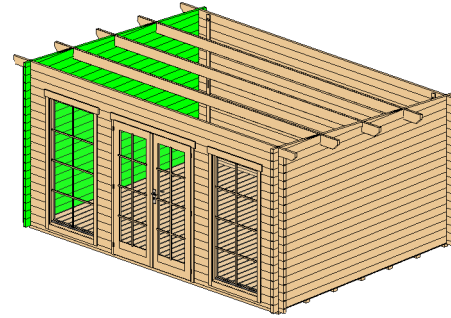

Wall A			
Mark	Profile	Count	Cut Length

ALG-1*	40x114	1	915
ALG-2*	40x114	1	2536
ALG-3	40x114	18	3500
ALG-4*	40x114	1	3500

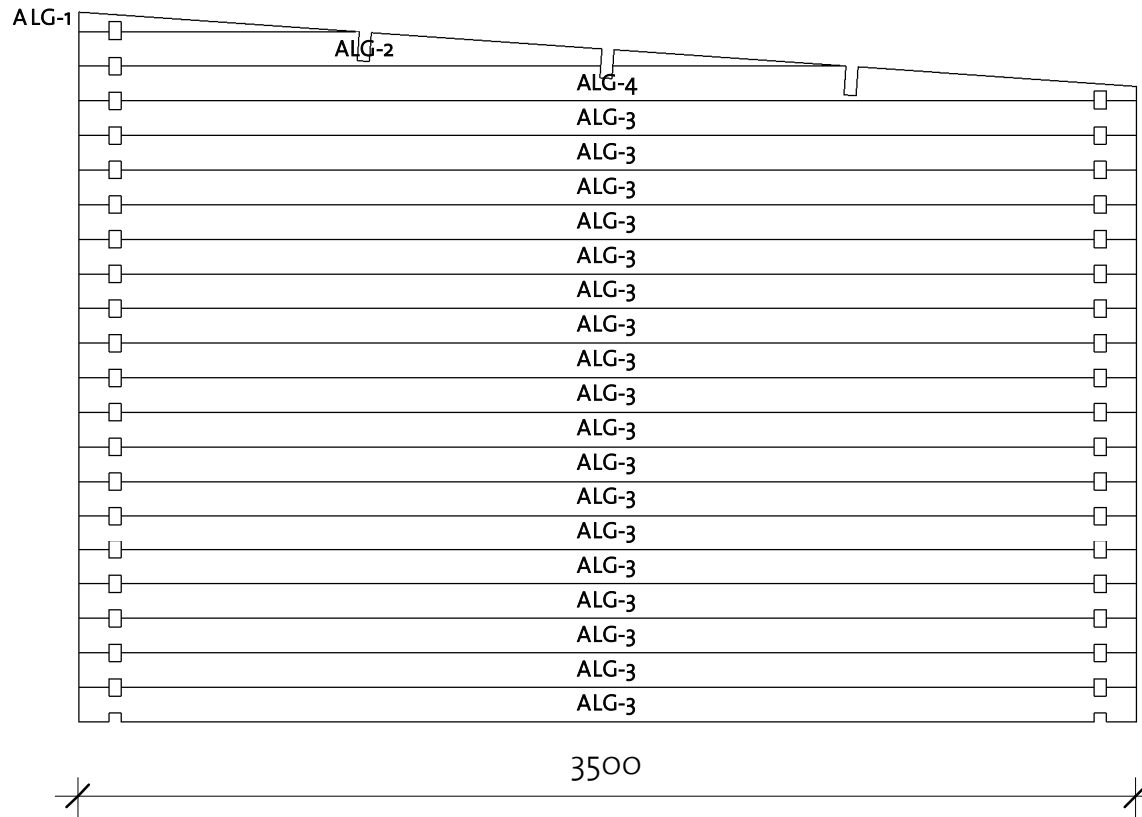

* Gable - delivered premounted

Log Profile Wall A	
Profile	Profile

40x114	
--------	--

Jody 40 (450x330)

Wall B

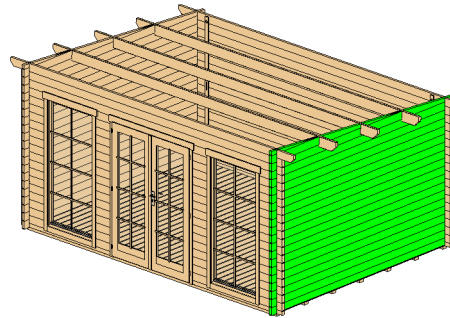

Wall B			
Mark	Profile	Count	Cut Length

BLG-1*	40x114	1	915
BLG-2*	40x114	1	2536
BLG-3	40x114	18	3500
BLG-4*	40x114	1	3500

* Gable - delivered premounted

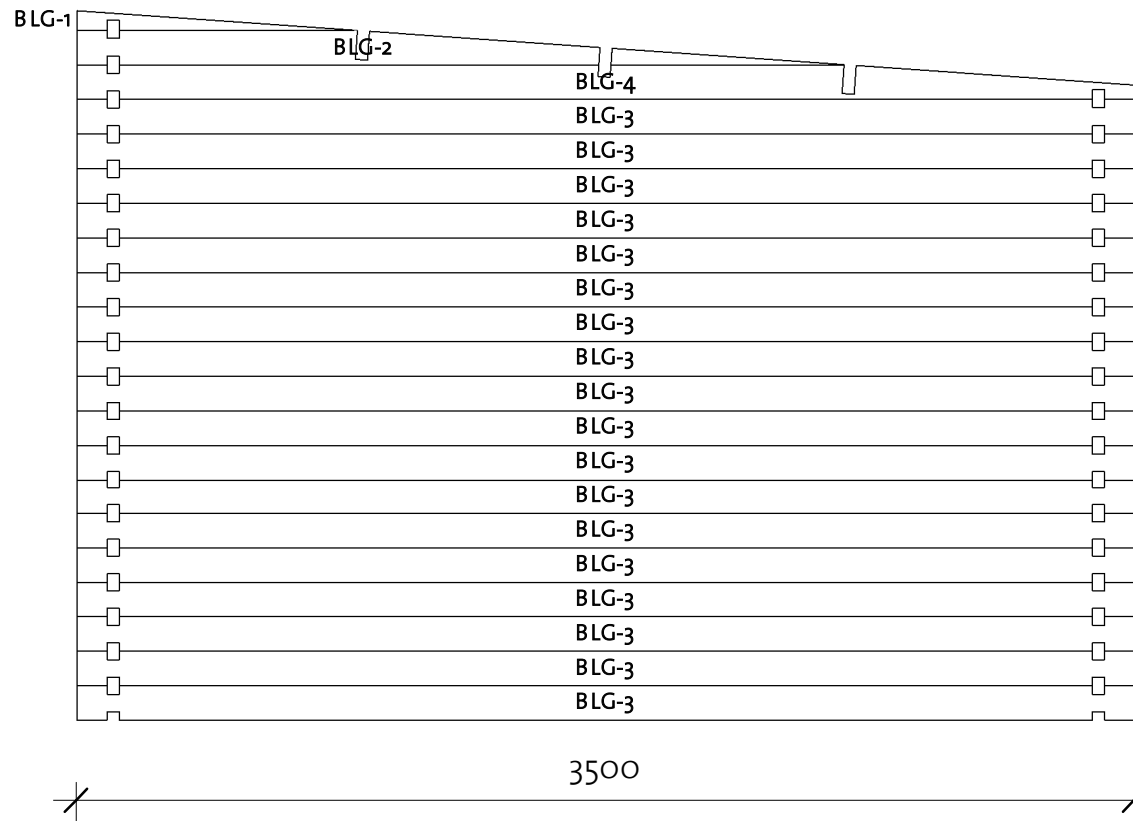

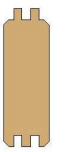

Log Profile Wall B	
Profile	Profile

40x114	
--------	---

Jody 40 (450x330)

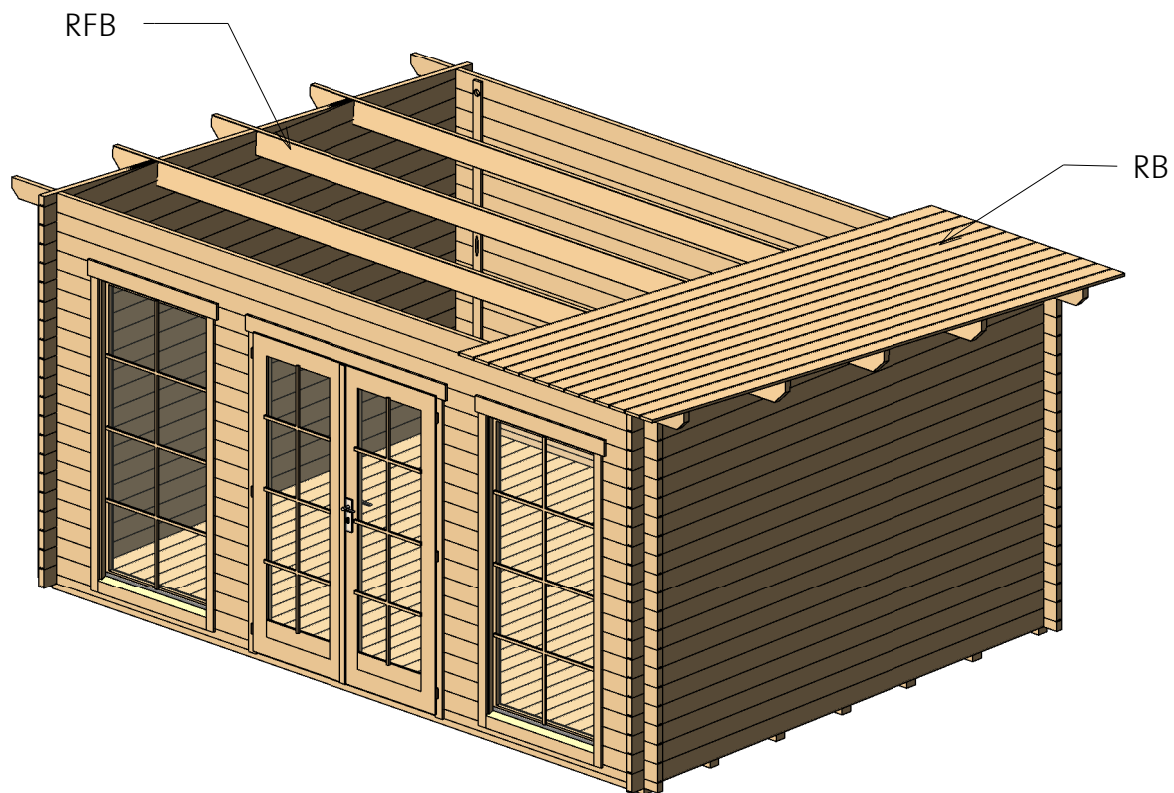
Roof 1



Roof				
Mark	Type	Profile	Count	Length
RFB	Beam 40x143		3	5100
RB	17x114		46	3868

Jody 40 (450x330)

Roof 2

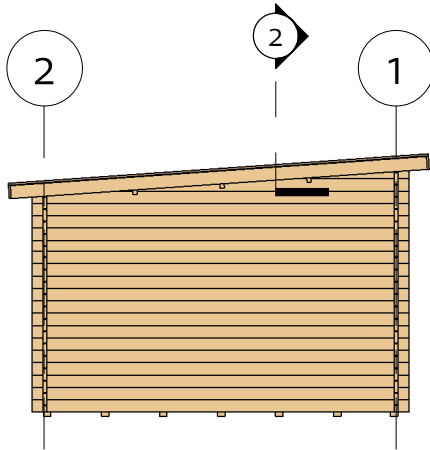

② Facia

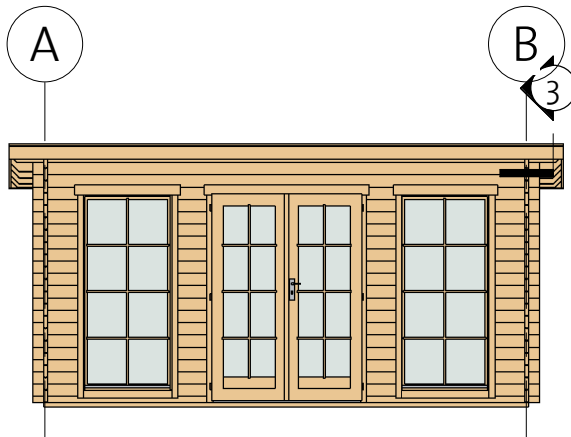
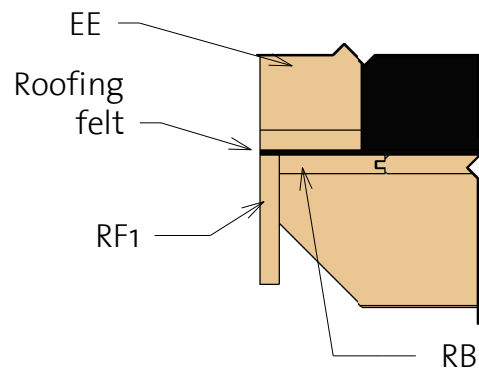

③ Roof Reinforcement

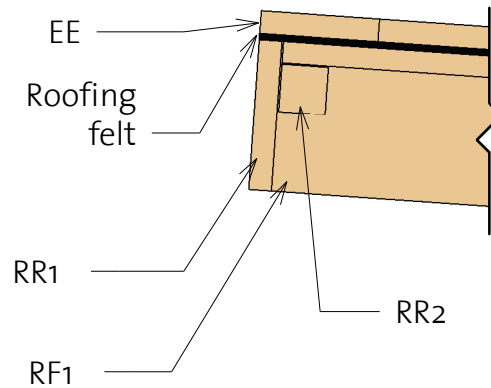

Fascia Schedule

Mark	Type	Profile	Count	Length
EE1	Eave Edging 18x95		2	3810
EE2	Eave Edging 18x95		1	5140
RF1	Roof Fascia 18x120		2	3869
RR1	Roof reinforcement 18x120		2	5140
RR2	Roof reinforcement 38x38		2	5100

Jody 40 (450x330)

Extras

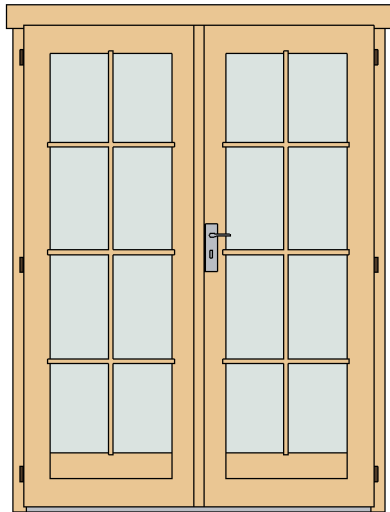

Door Schedule				
Mark	Type	Width	Height	Count
CDD3R	Classic double door 3 right	1425	1955	1
DCB8	Door Crossbar 8	--	--	2

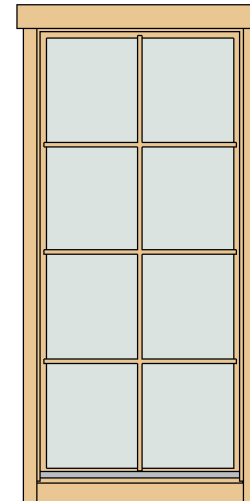

Window Schedule				
Mark	Type	Width	Height	Count
CW4R	Classic window 4, right	875	1890	2
WCB8	Windows Crossbar 8	--	--	2

* Windows intended for tilt opening only!

Fasteners/Extras		
Name	Type	Count

Hitblock	300-400 mm	
Bolts	M8 x 70	12
Screws	5,0 x 70	16
Screws	6,0 x 140	45
Nails	1,4 x 40	45
Screws	4,0 x 40	670

Type	Count	Length
------	-------	--------

Windboard 18x40	4	2200
-----------------	---	------





Jody 40 (450x330)

List of all items 1



Impregnated foundation beams

Mark	Type	Profile	Count	Length
IFB	IFB 70x40		7	4490





Floor Schedule

Mark	Type	Profile	Count	Length
FB	FB 17x114		40	3214
BB1	BB 20x40		2	4500
BB2	BB 20x40		2	3300

Roof

Mark	Type	Profile	Count	Length
RFB	Beam 40x143		3	5100
RB	17x114		46	3868

Fascia Schedule

Mark	Type	Profile	Count	Length
EE1	Eave Edging 18x95		2	3810
EE2	Eave Edging 18x95		1	5140
RF1	Roof Fascia 18x120		2	3869
RR1	Roof reinforcement 18x120		2	5140
RR2	Roof reinforcement 38x38		2	5100

Jody 40 (450x330)

List of all items 2

Wall 1

Mark	Profile	Count	Cut Length
------	---------	-------	------------

1BL-1	40x57	2	1630
1LG-1	40x114	34	310
1LG-2	40x114	34	435
1LG-3	40x114	2	4700
1TL-1	40x114	1	5100

Wall A

Mark	Profile	Count	Cut Length
------	---------	-------	------------

ALG-1*	40x114	1	915
ALG-2*	40x114	1	2536
ALG-3	40x114	18	3500
ALG-4*	40x114	1	3500

Wall 2

Mark	Profile	Count	Cut Length
------	---------	-------	------------

2BL-1	40x57	1	4700
2LG-1	40x114	17	4700
2TL-1	40x114	1	5100

Wall B



Mark	Profile	Count	Cut Length
------	---------	-------	------------

BLG-1*	40x114	1	915
BLG-2*	40x114	1	2536
BLG-3	40x114	18	3500
BLG-4*	40x114	1	3500

* Gable - delivered premounted

Log Profiles

Profile	Profile
---------	---------

40x57	
40x114	

Log Profiles

Profile	Profile
---------	---------

40x114	
--------	---