

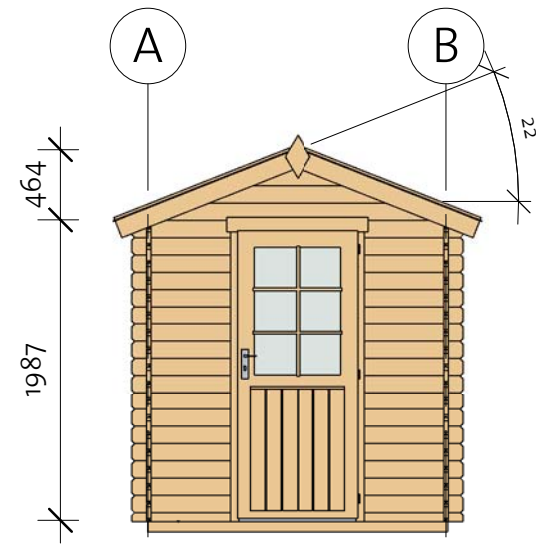

Tiffin A / Tiina A 28 (200x200)

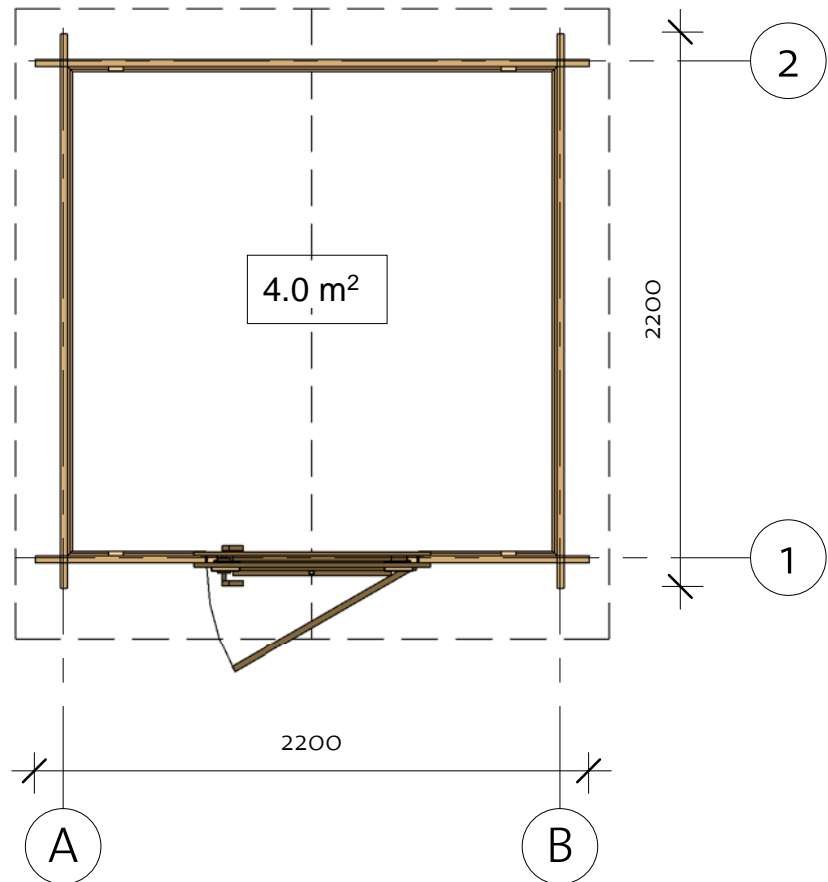
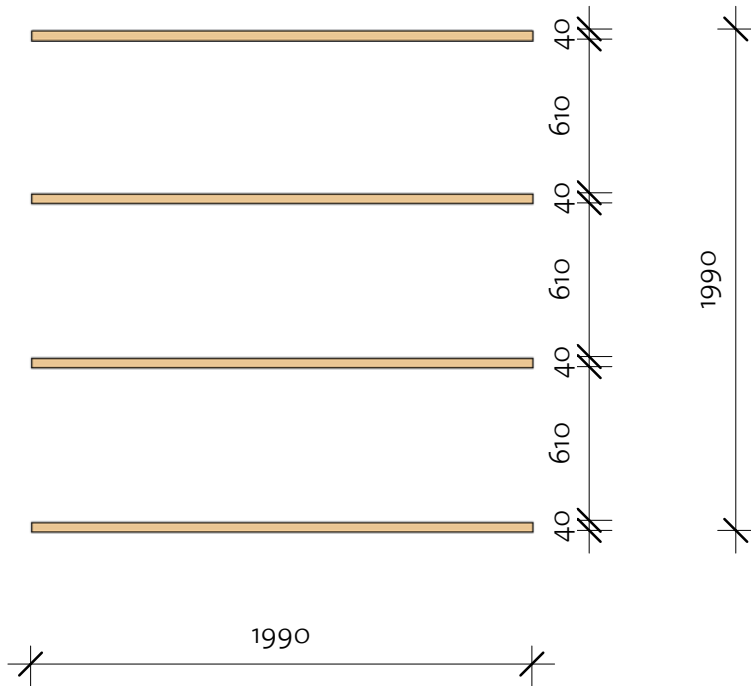

Tiina A 28 (200x200)

Foundation



Impregnated foundation beams				
Mark	Type	Profile	Count	Length
IFB	IFB 40x70		4	1990

Tiina A 28 (200x200)

Floor Plan

① Baseboard

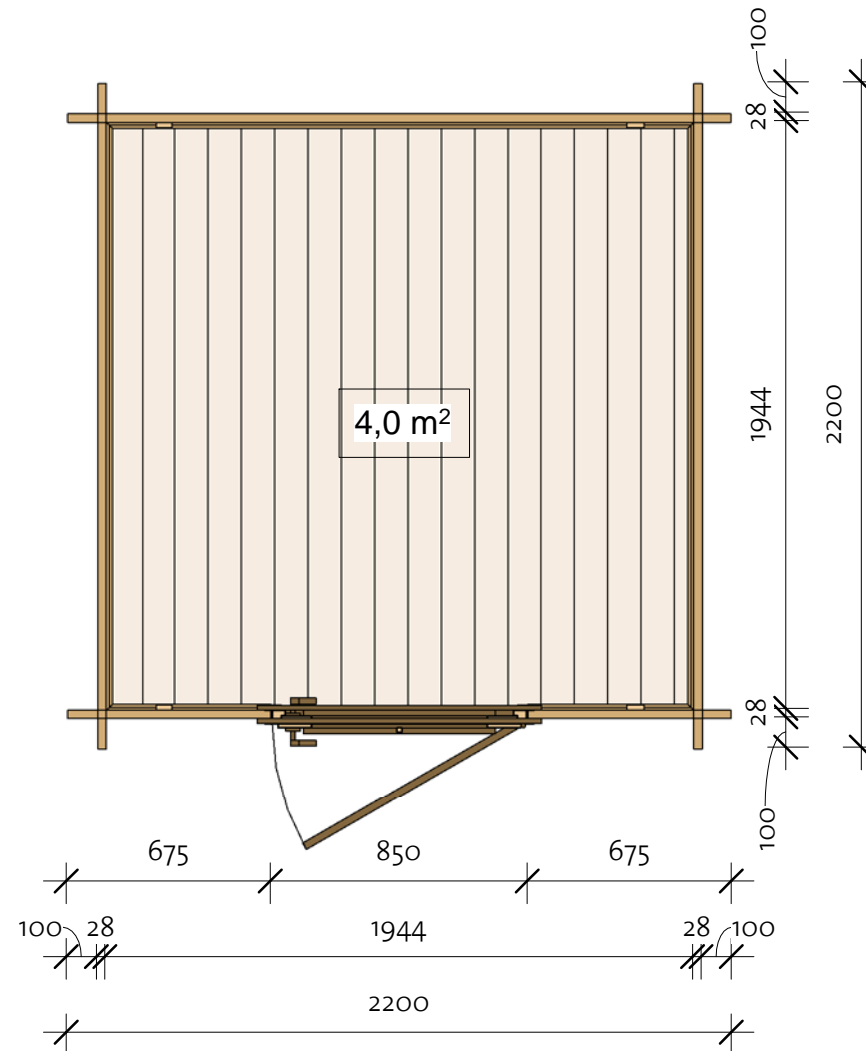
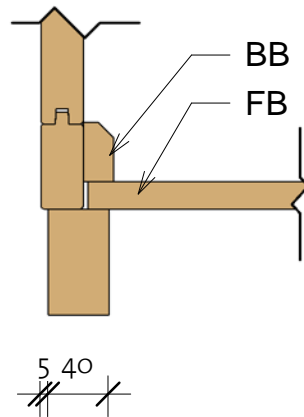

Floor Schedule

Mark	Type	Profile	Count	Length
------	------	---------	-------	--------

FB	FB 18x110		19	1938
----	-----------	---	----	------

BB	BB 20x40		4	2000
----	----------	---	---	------

91811261_190929

Tiina A 28 (200x200)

Wall 1

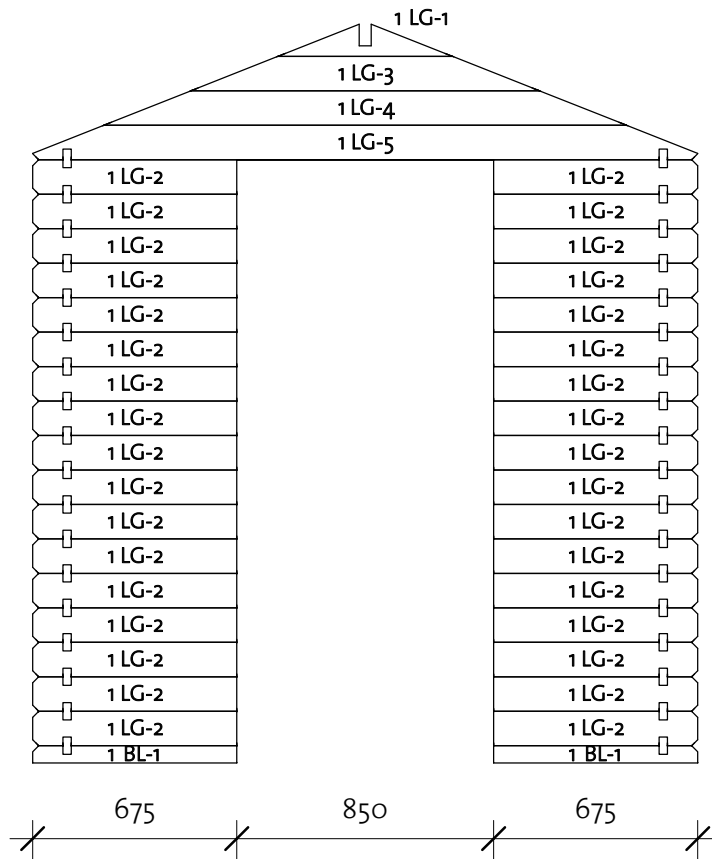
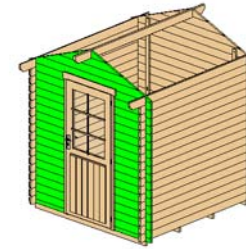



Wall 1			
Mark	Profile	Count	Cut Length

1BL-1	28x57	2	675
1LG-1 *	28x114	1	577
1LG-2	28x114	34	675
1LG-3 *	28x114	1	1153
1LG-4 *	28x114	1	1729
1LG-5 *	28x114	1	2200

* Gable - delivered premounted

Log Profile Wall 1	
Profile	Profile

28x57	
28x114	

Tiina A 28 (200x200)

Wall 2

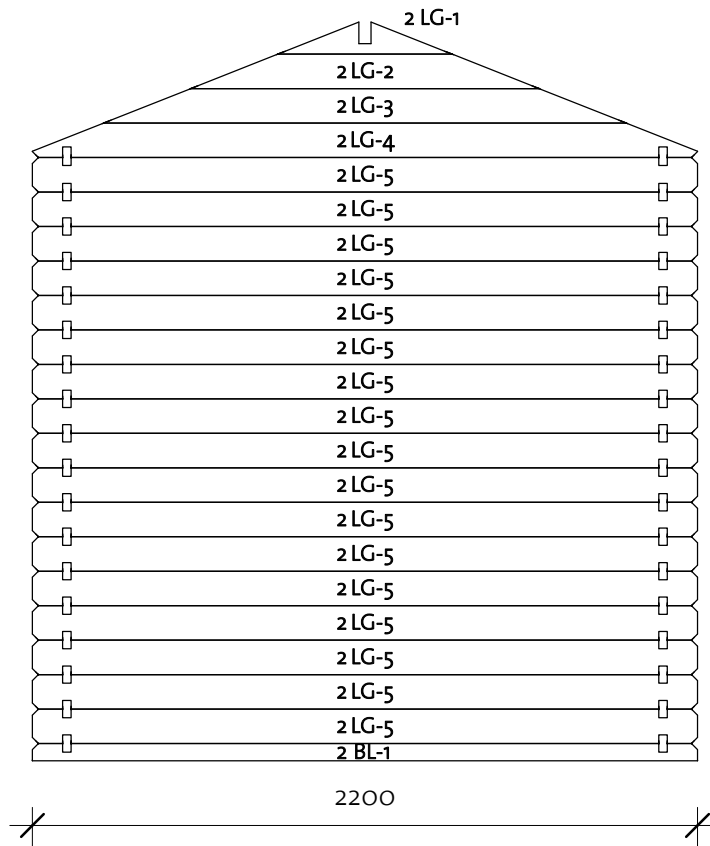
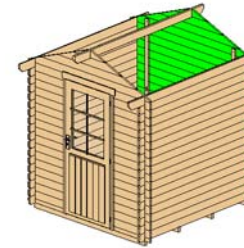



Wall 2			
Mark	Profile	Count	Cut Length

2BL-1	28x57	1	2200
2LG-1*	28x114	1	577
2LG-2*	28x114	1	1153
2LG-3*	28x114	1	1729
2LG-4*	28x114	1	2200
2LG-5	28x114	17	2200

* Gable - delivered premounted

Log Profile Wall 2	
Profile	Profile

28x57	
28x114	

Tiina A 28 (200x200)

Wall A



Wall A			
Mark	Profile	Count	Cut Length
ALG-1	28x114	17	2200
ATL-1	28x123	1	2500

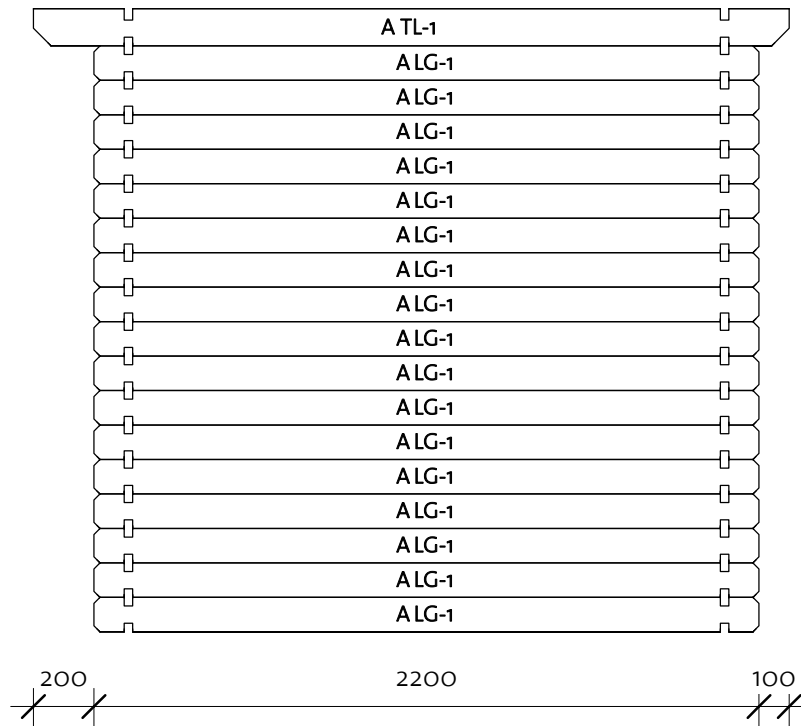

Log Profile Wall A	
Profile	Profile
28x114	
28x123	

Tiina A 28 (200x200)

Wall B

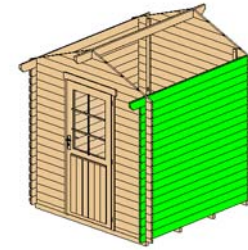

Wall B			
Mark	Profile	Count	Cut Length
BLG-1	28x114	17	2200
BTL-1	28x123	1	2500

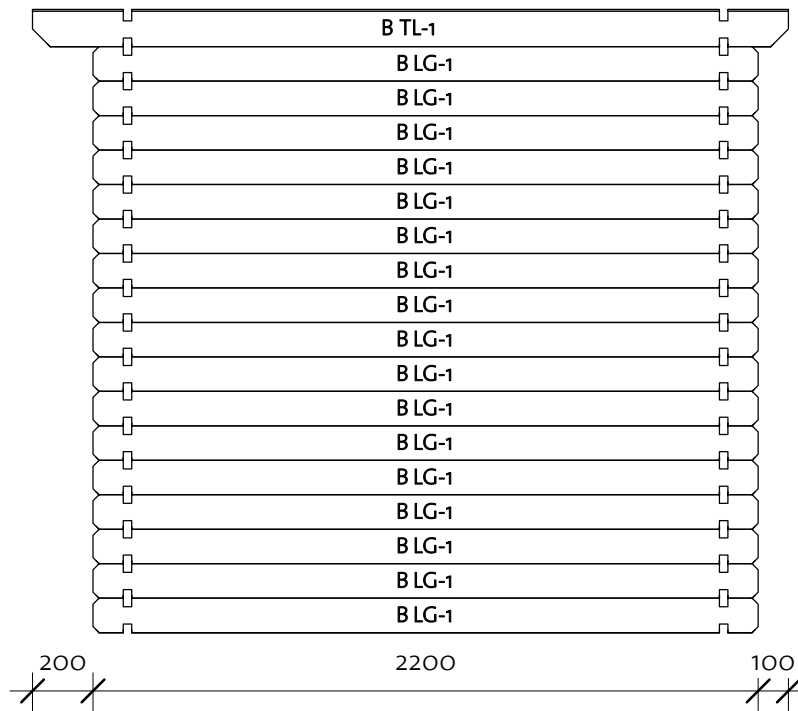



Log Profile Wall B	
Profile	Profile
28x114	
28x123	

Tiina A 28 (200x200)

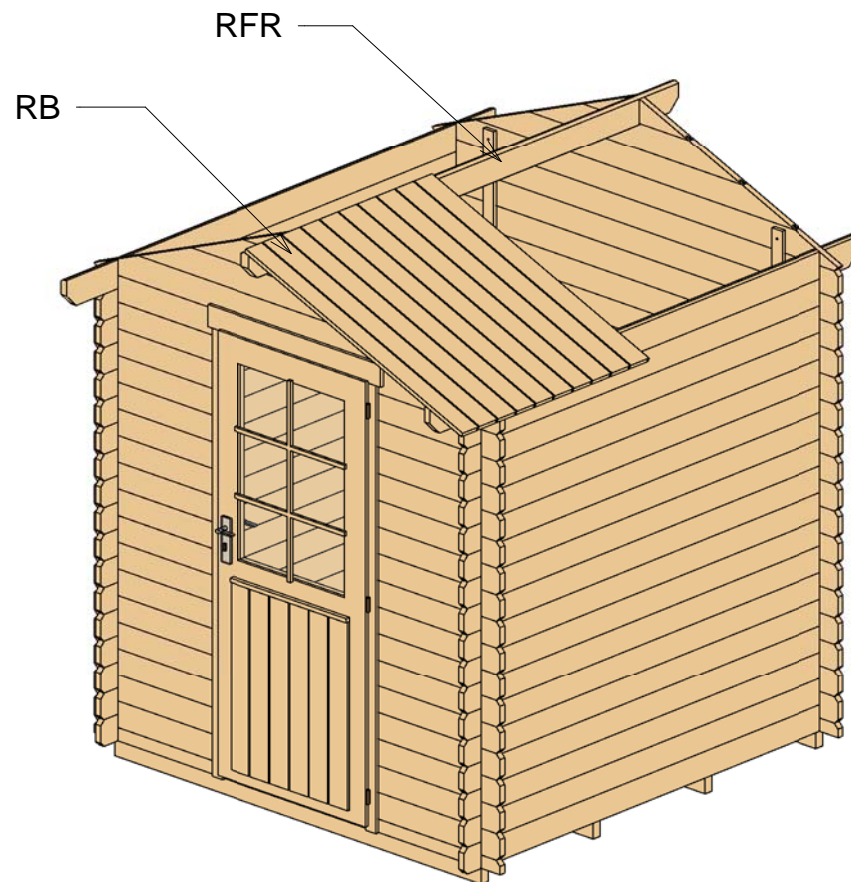
Roof 1



Roof				
Mark	Type	Profile	Count	Length
RFR	Ridge 40x120		1	2500
RB	18x110		48	1267

Tiina A 28 (200x200)

Roof 2

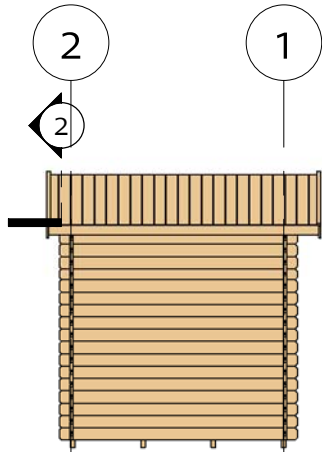

② Facia

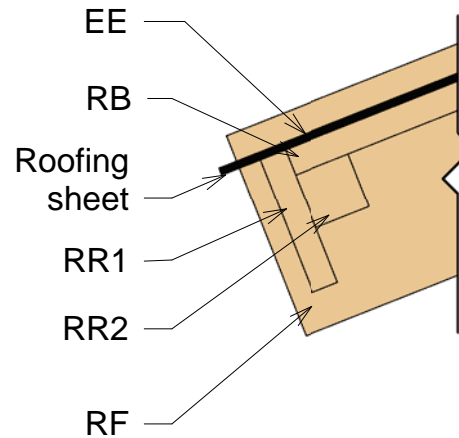

③ Roof Reinforcement

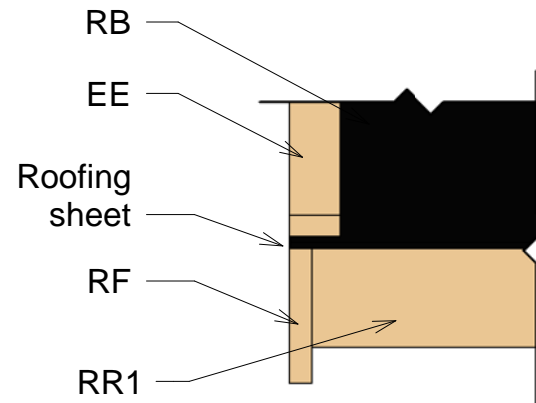
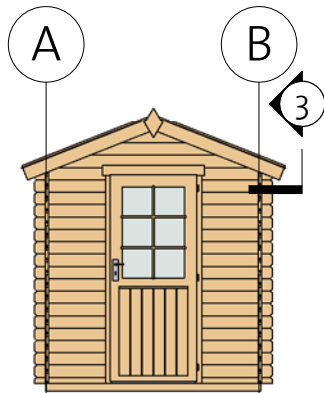

Fascia Schedule

Mark	Type	Profile	Count	Length
EE	Eave Edging 18x40		4	1300
RF	Roof Fascia 18x120		4	1300
RR1	Roof reinforcement 18x95		2	2500
RR2	Roof reinforcement 38x38		2	2500

Tiina A 28 (200x200)

Extras



Door Schedule				
Model	Type	Width	Height	Count
BD3R	Basic door 3 right	840	1955	1
DCB6	Door Crossbar 6	--	--	1

Fasteners & Extras		
Name	Type	Count

Hitblock	300-400 mm	
Bolts	M8 x 60	12
Screws	5,0 x 70	15
Nails	1,4 x 40	20
Screws	6,0 x 140	20
Screws	4,0 x 40	60
Screws	4,0 x 50	200

Type	Count	Length
------	-------	--------

Windboard 18x40	4	2200
-----------------	---	------

Family	Count
--------	-------



Romb	2
------	---



Tiina A 28 (200x200)

List of all items 1



Roof				
Mark	Type	Profile	Count	Length

RFR	Ridge 40x120		1	2500
RB	18x110		48	1267





Impregnated foundation beams				
Mark	Type	Profile	Count	Length

IFB	IFB 40x70		4	1990
-----	--------------	---	---	------

Floor Schedule				
Mark	Type	Profile	Count	Length

FB	FB 18x110		19	1938
BB	BB 20x40		4	2000

Fascia Schedule				
Mark	Type	Profile	Count	Length

EE	Eave Edging 18x40		4	1300
RF	Roof Fascia 18x120		4	1300
RR1	Roof reinforcement 18x95		2	2500
RR2	Roof reinforcement 38x38		2	2500

Tiina A 28 (200x200)

List of all items 2

Wall 1			
Mark	Profile	Count	Cut Length

1BL-1	28x57	2	675
1LG-1 *	28x114	1	577
1LG-2	28x114	34	675
1LG-3 *	28x114	1	1153
1LG-4 *	28x114	1	1729
1LG-5 *	28x114	1	2200

Wall 2			
Mark	Profile	Count	Cut Length

2BL-1	28x57	1	2200
2LG-1 *	28x114	1	577
2LG-2 *	28x114	1	1153
2LG-3 *	28x114	1	1729
2LG-4 *	28x114	1	2200
2LG-5	28x114	17	2200

* Gable - delivered premounted

Wall A			
Mark	Profile	Count	Cut Length

ALG-1	28x114	17	2200
ATL-1	28x123	1	2500

Wall B			
Mark	Profile	Count	Cut Length

BLG-1	28x114	17	2200
BTL-1	28x123	1	2500

Log Profiles	
Profile	Profile

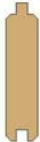
28x57	
28x114	

Log Profiles	
Profile	Profile

28x123	
--------	---