

Atypik_UHLEN 40

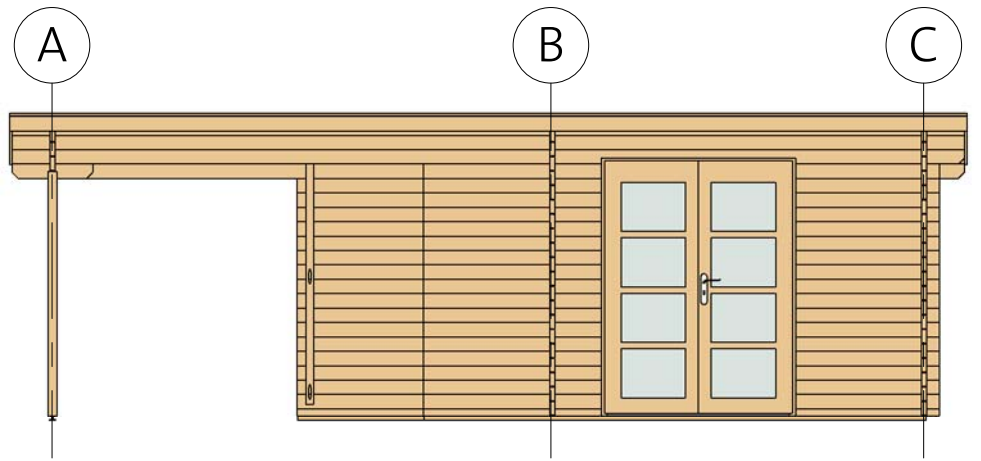

Atypik_UHLEN 40

Foundation

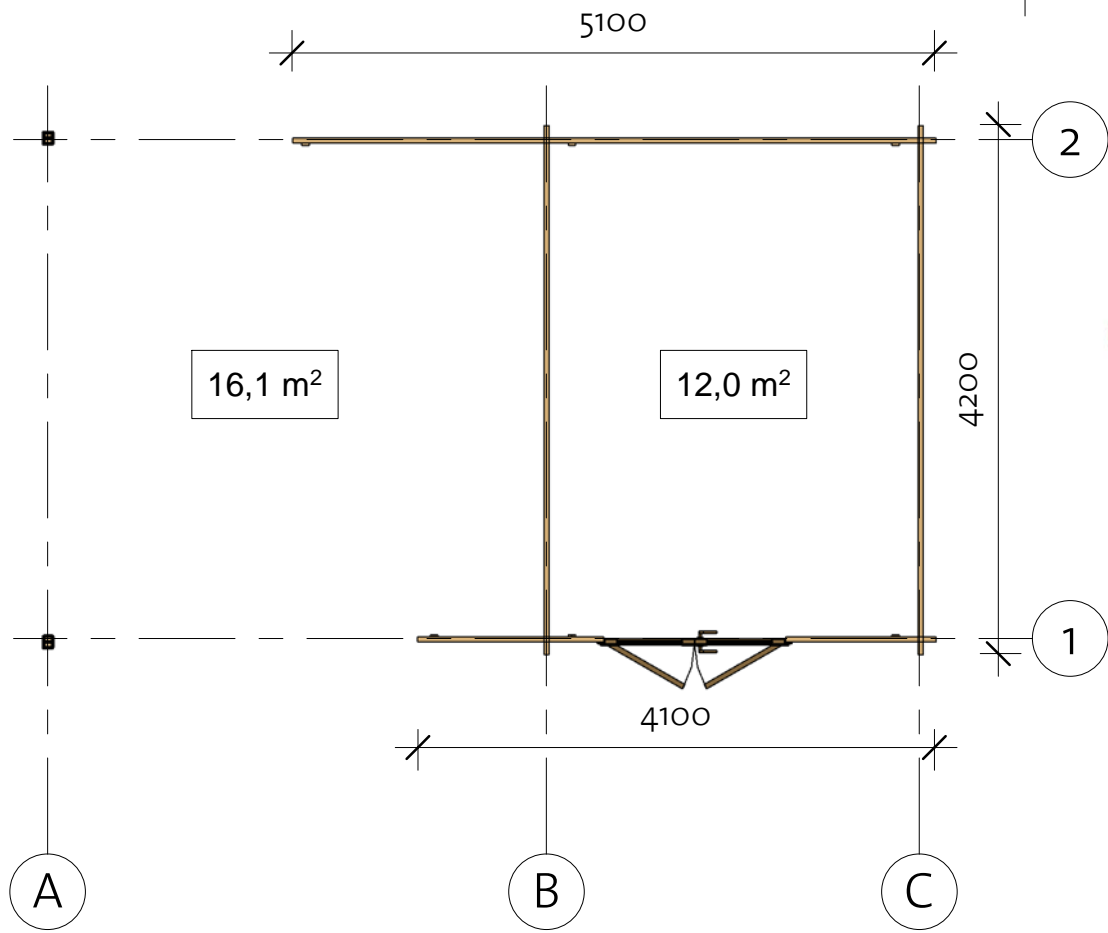
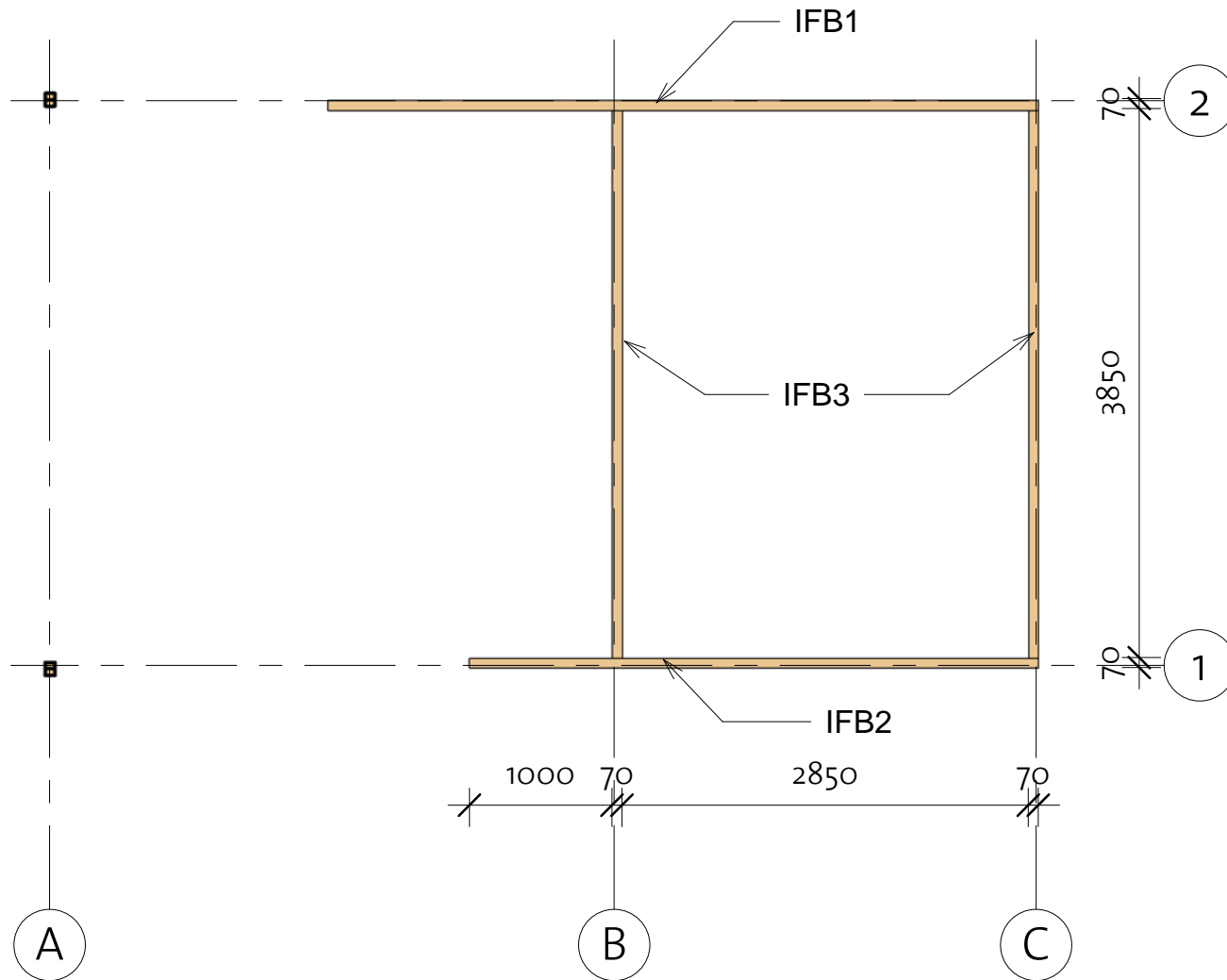

Impregnated foundation beams				
Mark	Type	Profile	Count	Length

IFB1	IFB 70x45		1	4990
IFB2	IFB 70x45		1	3990
IFB3	IFB 70x45		2	3850

Atypik_UHLEN 40

Floor Plan

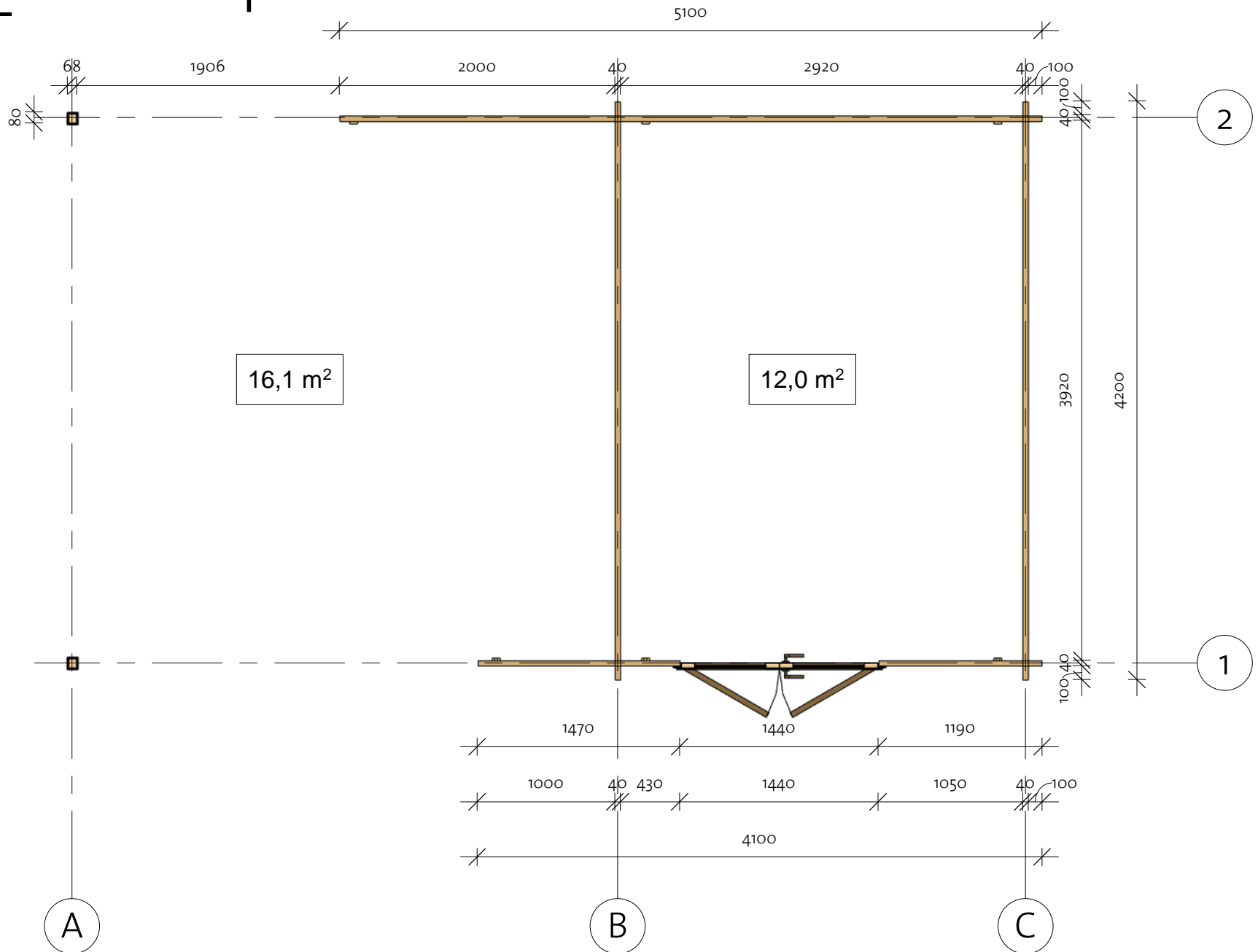

Atypik_UHLEN 40

Wall 1

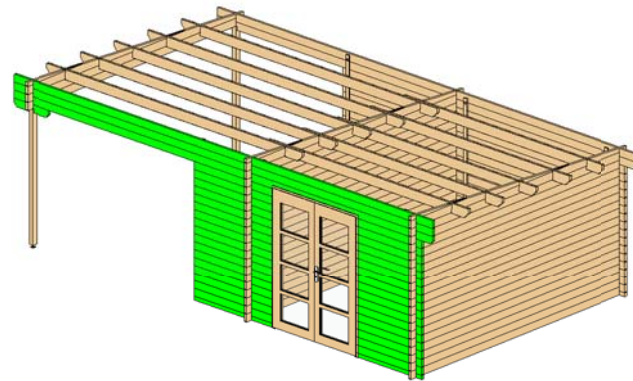

Log Profile Wall 1	
Profile	Profile

40X57	
40X114	
40X114	

Wall 1			
Mark	Profile	Count	Cut Length

1BL-1	40X57	1	1190
1BL-2	40X57	1	1470
1LG-1	40X114	17	1190
1LG-2	40X114	17	1470
1LG-3	40X114	1	3280
1LG-4	40X114	1	3280
1LG-5	40X114	2	4280
1LG-6	40X114	1	640
1TL-1	40X114	1	3280
1TL-2	40X114	1	4280

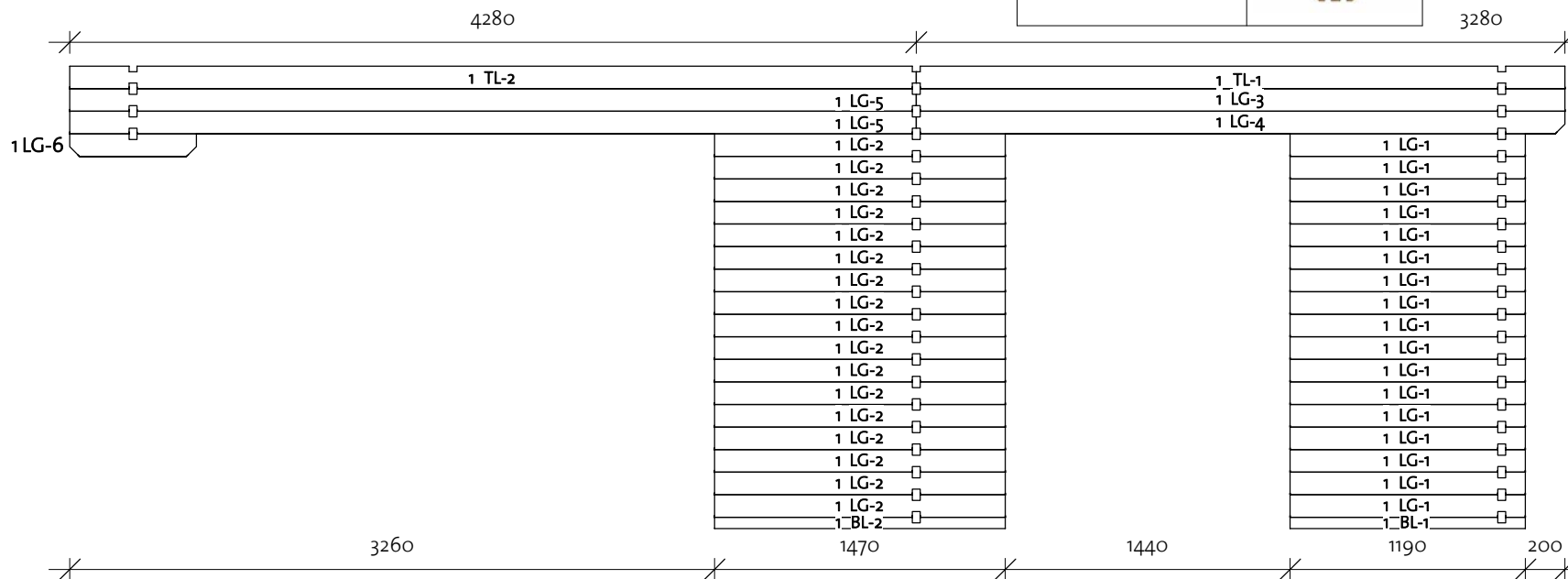

Atypik_UHLEN 40

Wall 2

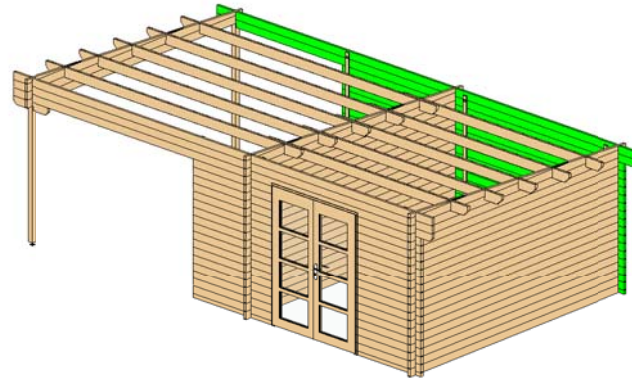

Log Profile Wall 2	
Profile	Profile

40x57	
40x114	
40x114	

Wall 2			
Mark	Profile	Count	Cut Length

2BL-1	40x57	1	5100
2LG-1	40x114	16	5100
2LG-2	40x114	1	3280
2LG-3	40x114	1	4280
2TL-1	40x114	1	3280
2TL-2	40x114	1	4280

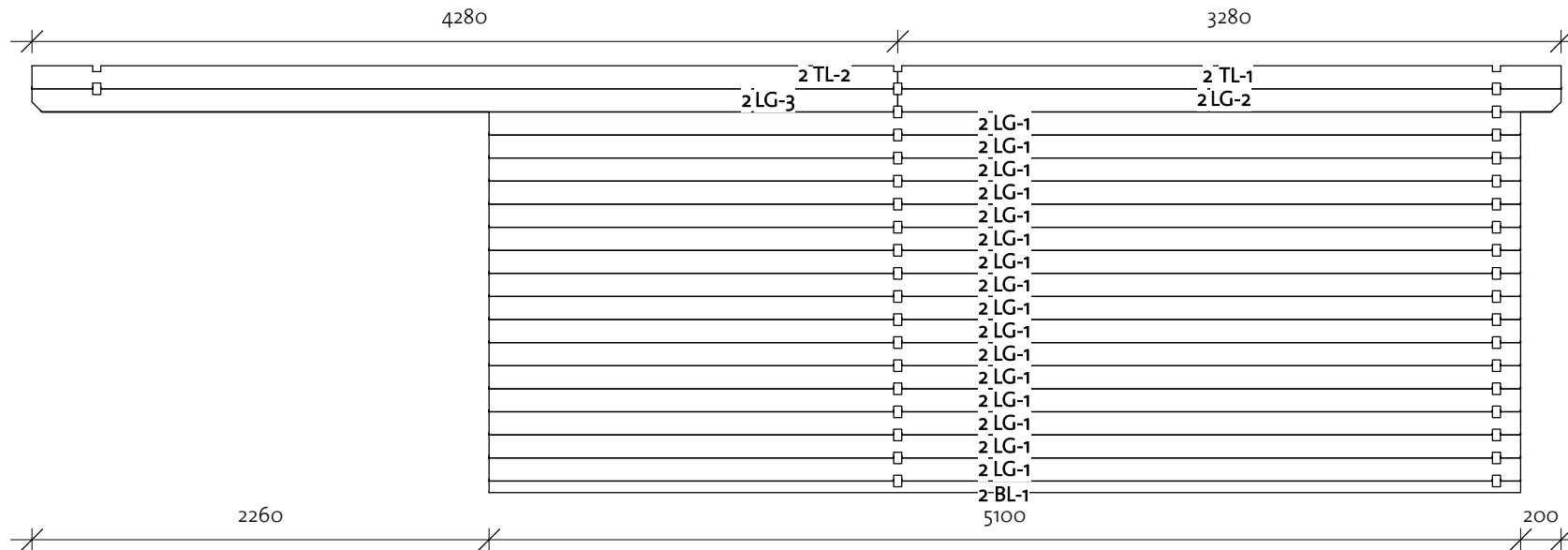

Atypik_UHLEN 40

Wall A

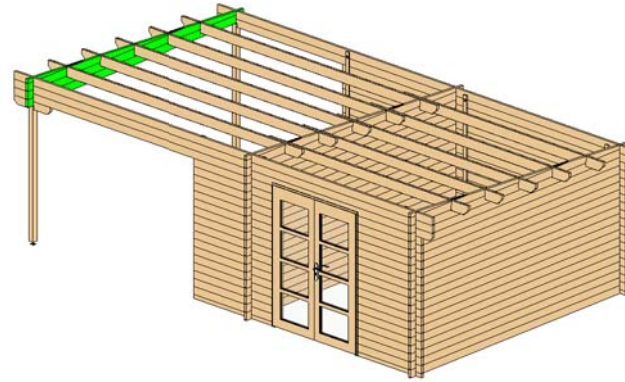

Wall A			
Mark	Profile	Count	Cut Length

ALG-1	40x114	1	1089
ALG-2	40x114	1	3068
ALG-3	40x114	1	4200
ALG-4	40x114	1	4200

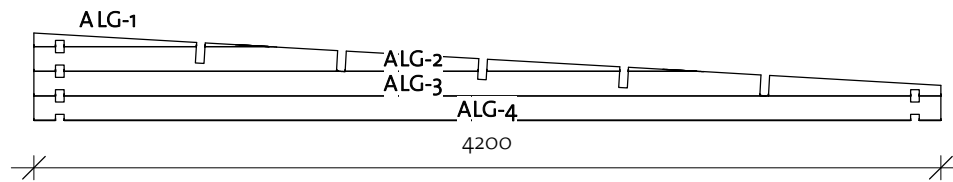

Log Profile Wall A	
Profile	Profile

40x114	
--------	--

Atypik_UHLEN 40

Wall B

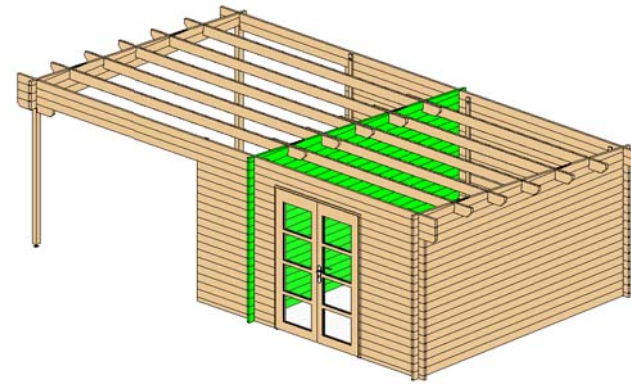

Wall B			
Mark	Profile	Count	Cut Length

BLG-1	40x114	1	1089
BLG-2	40x114	1	3068
BLG-3	40x114	1	4200
BLG-4	40x114	17	4200
BLG-5	40x114	1	4200

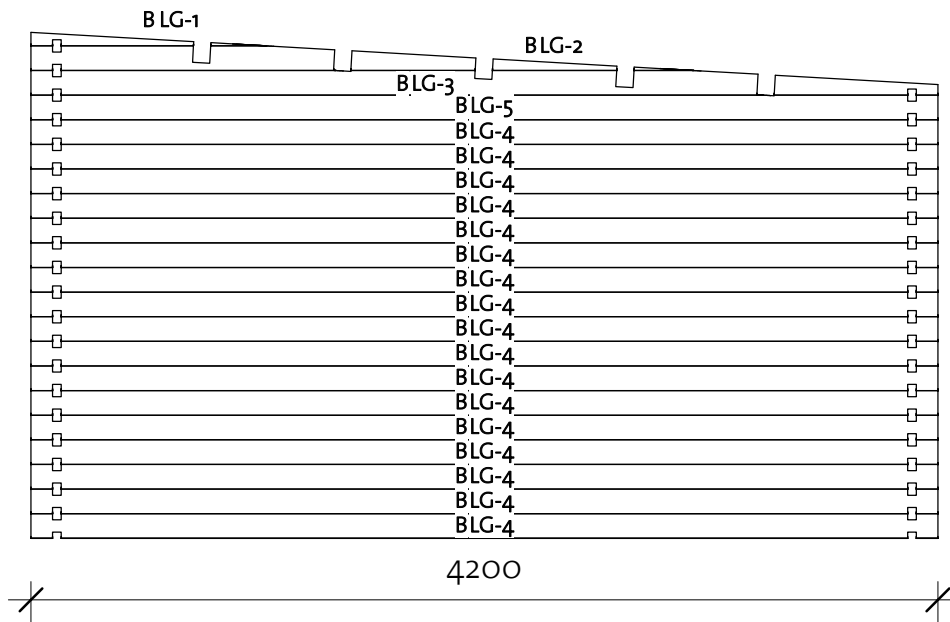

Log Profile Wall B	
Profile	Profile

40X114	
--------	--

Atypik_UHLEN 40

Wall C

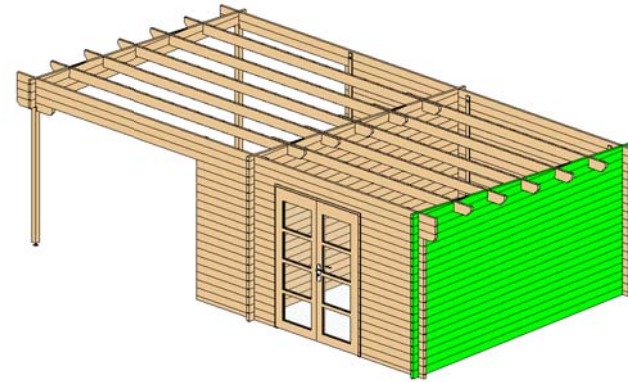

Wall C			
Mark	Profile	Count	Cut Length

CLG-1	40x114	1	1089
CLG-2	40x114	1	3068
CLG-3	40x114	1	4200
CLG-4	40x114	17	4200
CLG-5	40x114	1	4200

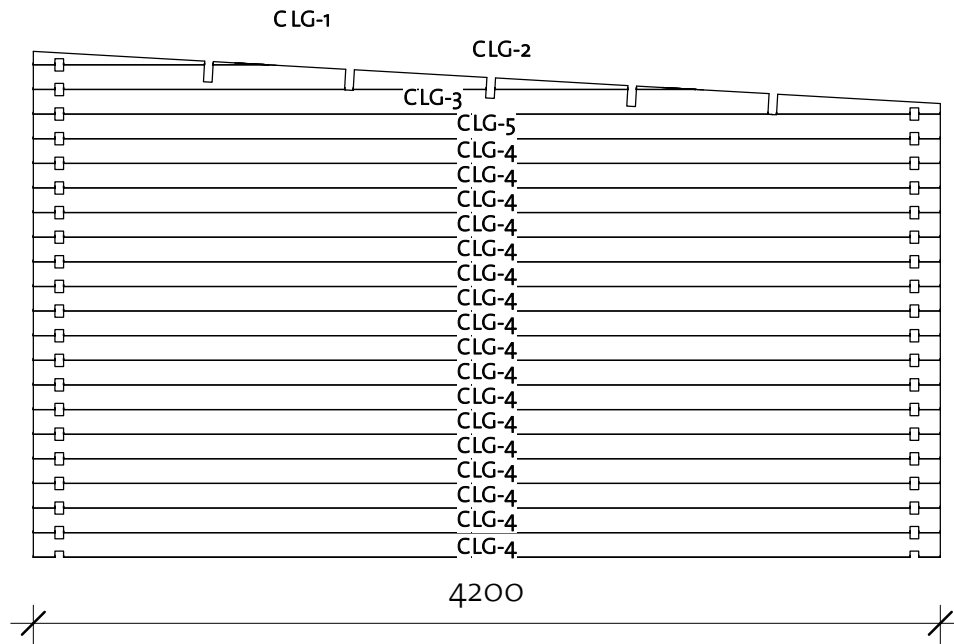





Log Profile Wall C	
Profile	Profile

40X114	
--------	--

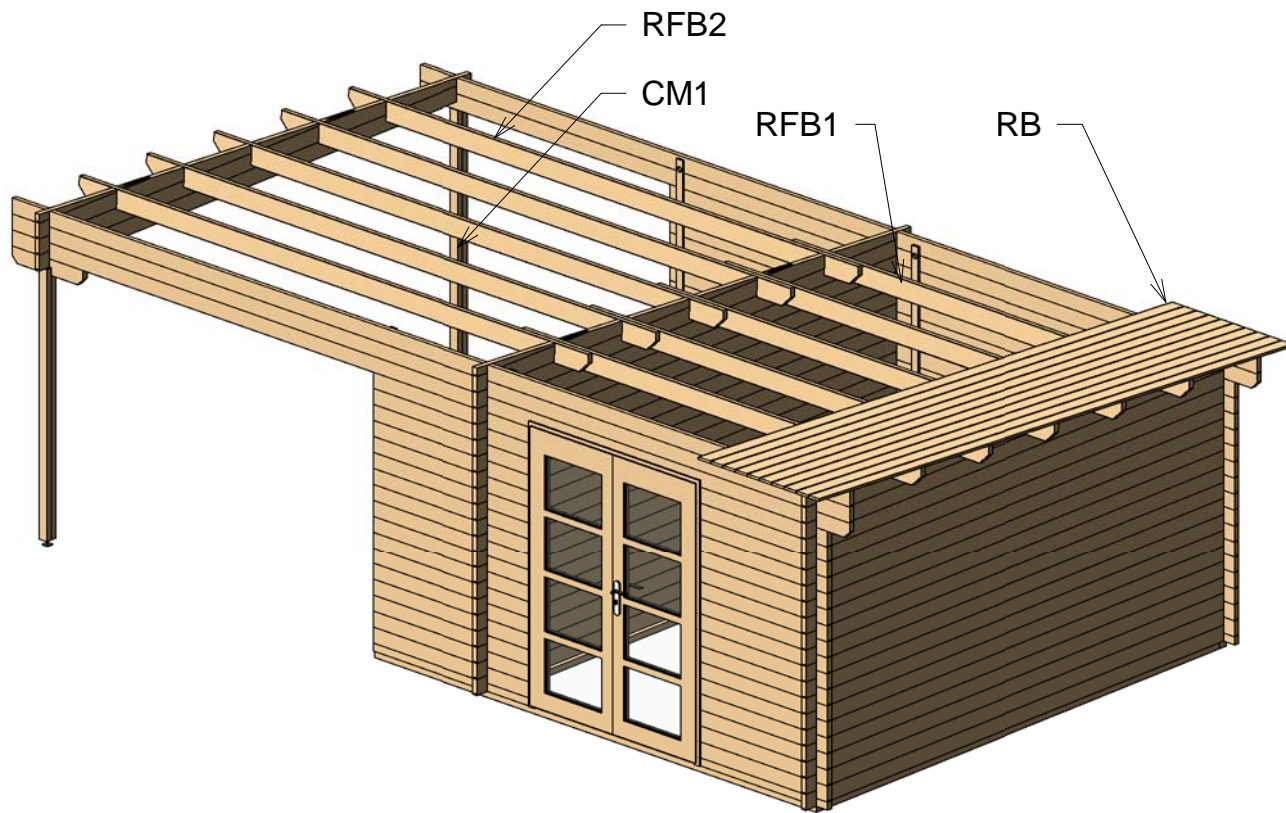
Atypik_UHLEN 40

Roof 1



Roof				
Mark	Type	Profile	Count	Length
RFB1	Beam 40x143		5	3600
RFB2	Beam 40x143		5	4600
RB	18x110		70	4610

Atypik_UHLEN 40

Roof 2

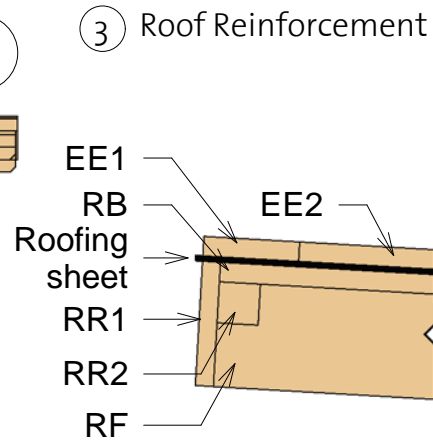
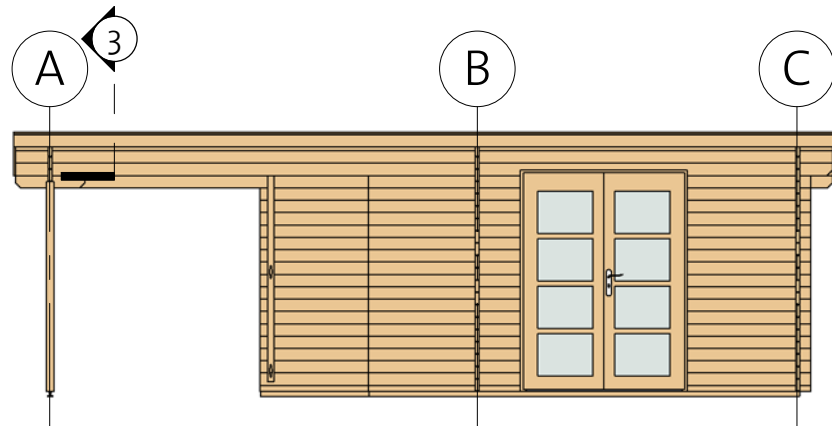
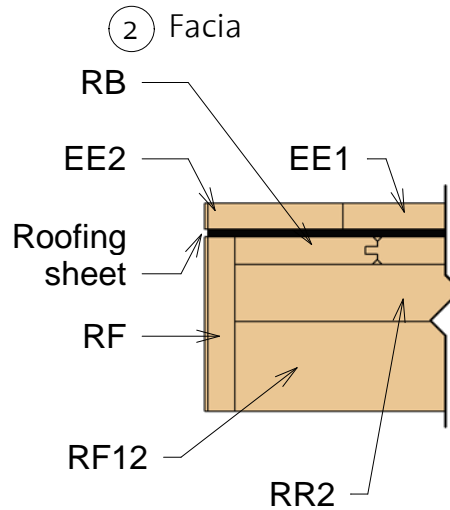
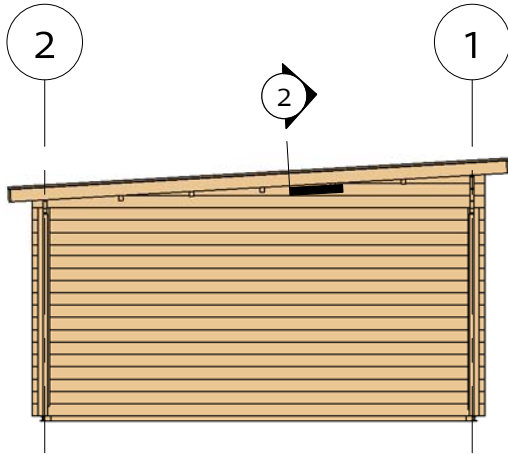

Fascia Schedule				
Mark	Type	Profile	Count	Length
EE1	Eave Edging 18x90		2	3800
EE2	Eave Edging 18x90		2	4560
RF	Roof Fascia 18x115		2	4610
RR1	Roof reinforcement 18x115		4	3800
RR2	Roof reinforcement 38x38		4	3780

Atypik_UHLEN 40

Extras

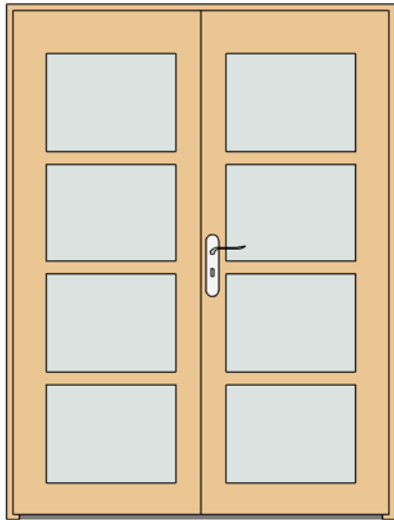

Door Schedule				
Mark	Type	Width	Height	Count
CDD2	Classic double door 2, four glass	1425	1955	1

Fasteners/Extras		
Name	Type	Count
Hitblock	300-400 mm	
Bolts	M8 x 70	18
Screws	6,0 x 140	50
Screws	4,0 x 40	140
Screws	4,0 x 50	550

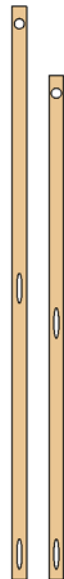

Type	Count
Adjustable post foot	2
Windboard 18x38 2000 mm	3
Windboard 18x38 2275 mm	3



I









Posts		
Profile	Count	Length
Post 45x70	2	1938

Atypik_UHLEN 40

List of all items 1

Roof				
Mark	Type	Profile	Count	Length
RFB1	Beam 40x143		5	3600
RFB2	Beam 40x143		5	4600
RB	18x110		70	4610

Impregnated foundation beams				
Mark	Type	Profile	Count	Length
IFB1	IFB 70x45		1	4990
IFB2	IFB 70x45		1	3990
IFB3	IFB 70x45		2	3850

Fascia Schedule				
Mark	Type	Profile	Count	Length
EE1	Eave Edging 18x90		2	3800
EE2	Eave Edging 18x90		2	4560
RF	Roof Fascia 18x115		2	4610
RR1	Roof reinforcement 18x115		4	3800
RR2	Roof reinforcement 38x38		4	3780

Atypik_UHLEN 40

List of all items 2



Wall 1			
Mark	Profile	Count	Cut Length

1BL-1	40x57	1	1190
1BL-2	40x57	1	1470
1LG-1	40x114	17	1190
1LG-2	40x114	17	1470
1LG-3	40x114	1	3280
1LG-4	40x114	1	3280
1LG-5	40x114	2	4280
1LG-6	40x114	1	640
1TL-1	40x114	1	3280
1TL-2	40x114	1	4280

Wall A			
Mark	Profile	Count	Cut Length

ALG-1	40x114	1	1089
ALG-2	40x114	1	3068
ALG-3	40x114	1	4200
ALG-4	40x114	1	4200

Log Profiles	
Profile	Profile

40x57	
40x114	

Wall 2			
Mark	Profile	Count	Cut Length

2BL-1	40x57	1	5100
2LG-1	40x114	16	5100
2LG-2	40x114	1	3280
2LG-3	40x114	1	4280
2TL-1	40x114	1	3280
2TL-2	40x114	1	4280

Wall B			
Mark	Profile	Count	Cut Length

BLG-1	40x114	1	1089
BLG-2	40x114	1	3068
BLG-3	40x114	1	4200
BLG-4	40x114	17	4200
BLG-5	40x114	1	4200

Wall C			
Mark	Profile	Count	Cut Length

CLG-1	40x114	1	1089
CLG-2	40x114	1	3068
CLG-3	40x114	1	4200
CLG-4	40x114	17	4200
CLG-5	40x114	1	4200

Log Profiles	
Profile	Profile

40x114	
--------	---